

bet.

2.00
2.00

SMIETNIK

m2

7/2:1

71

72

73

74

75

76

77

78

79

80

81

82

83

84

85

86

87

88

89

7/2:7

7/2:6

7/2:4

7/2:3

7/2:5

7/2:2

80

81

82

83

84

85

86

87

88

89

7/3:1

7/3:2

90

91

92

93

94

95

96

97

98

99

100

ažur bet.

ažur bet.

kost.bet.

kost.bet.

j.asf.

kost.bet.

ch.kost.bet.

ažur bet.

ažur bet.

Artyleryjska

Bogus

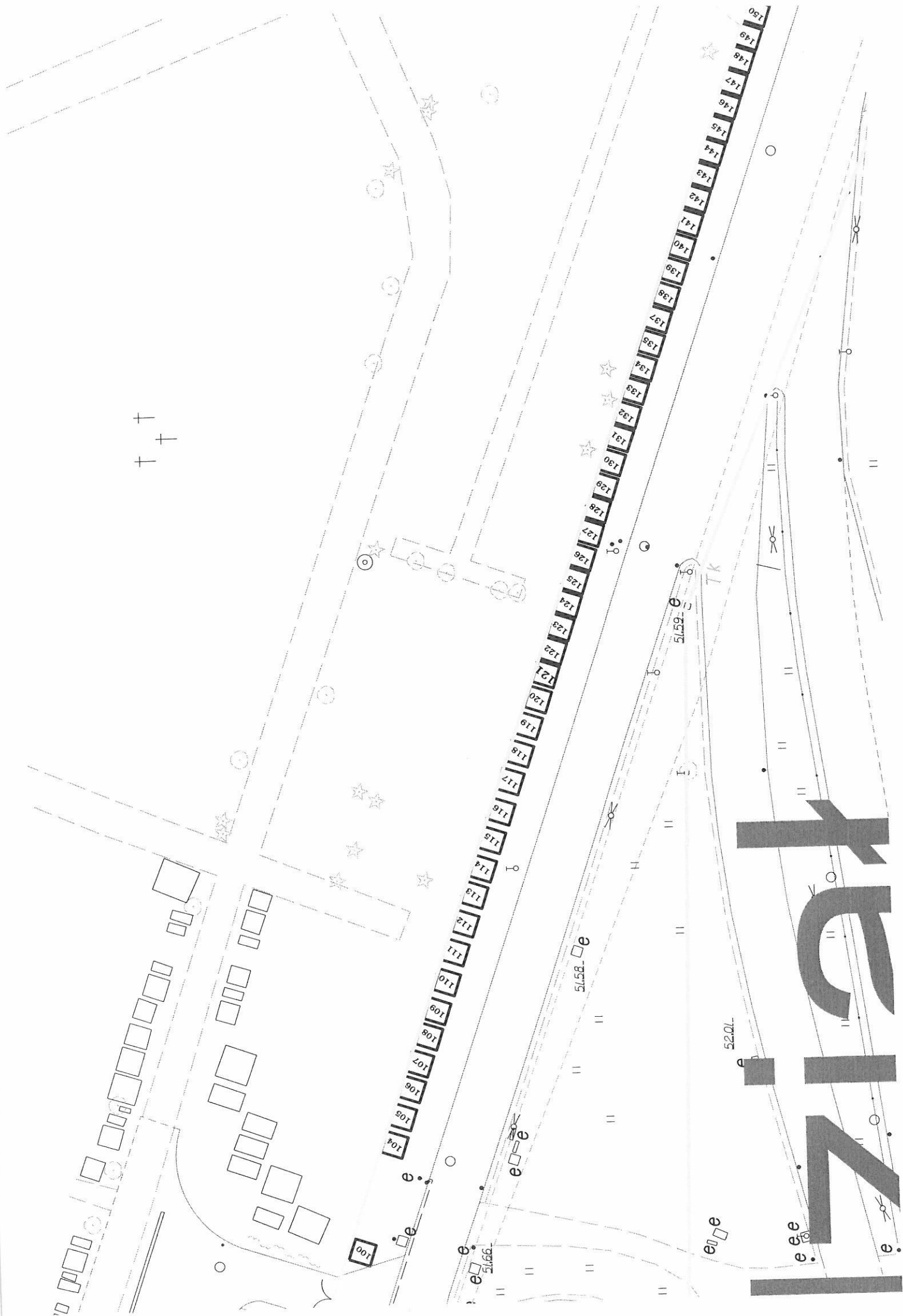

+

+

N

Artyleryjska

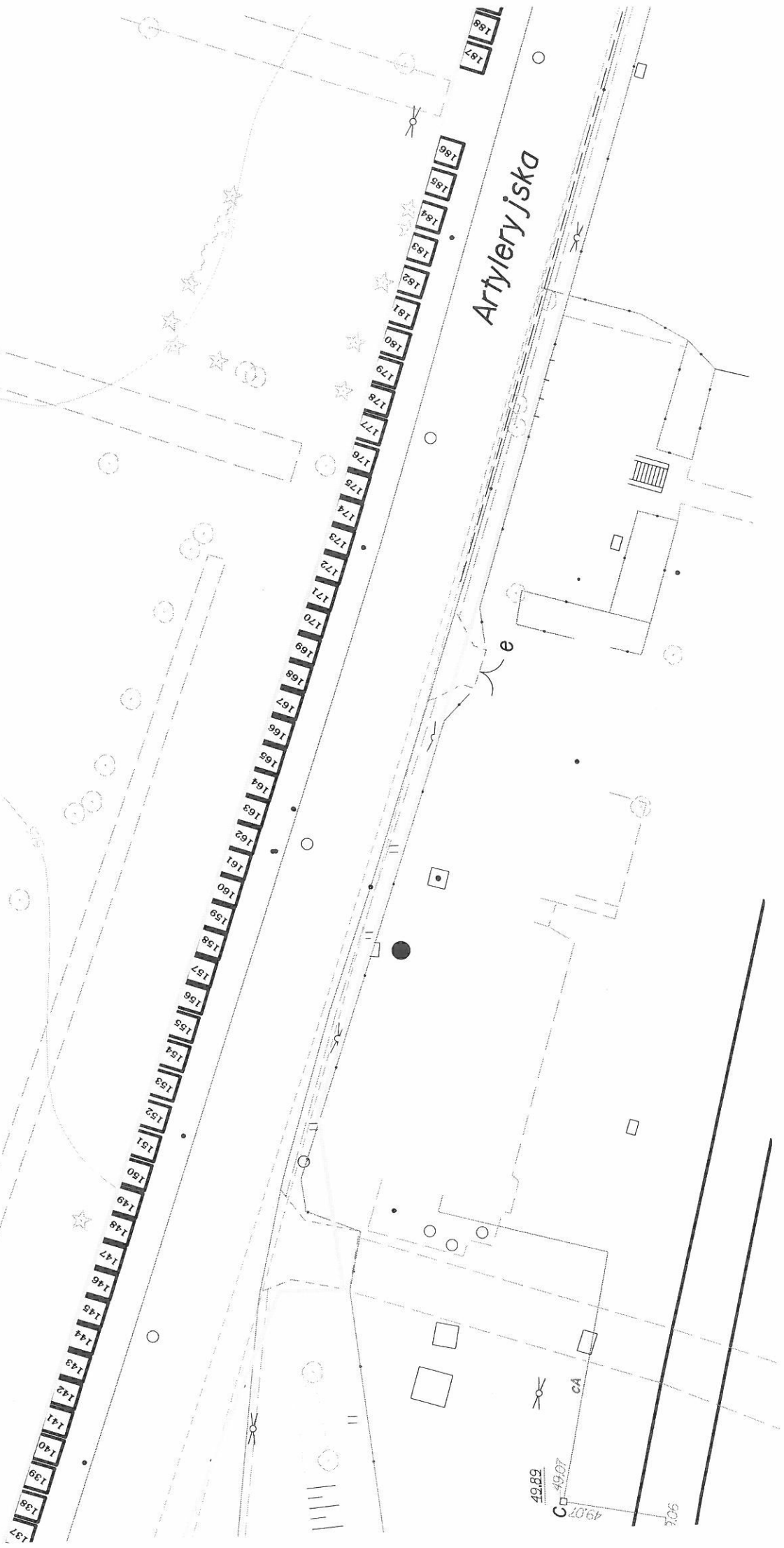

49.89
C 49.07
49.07

90x

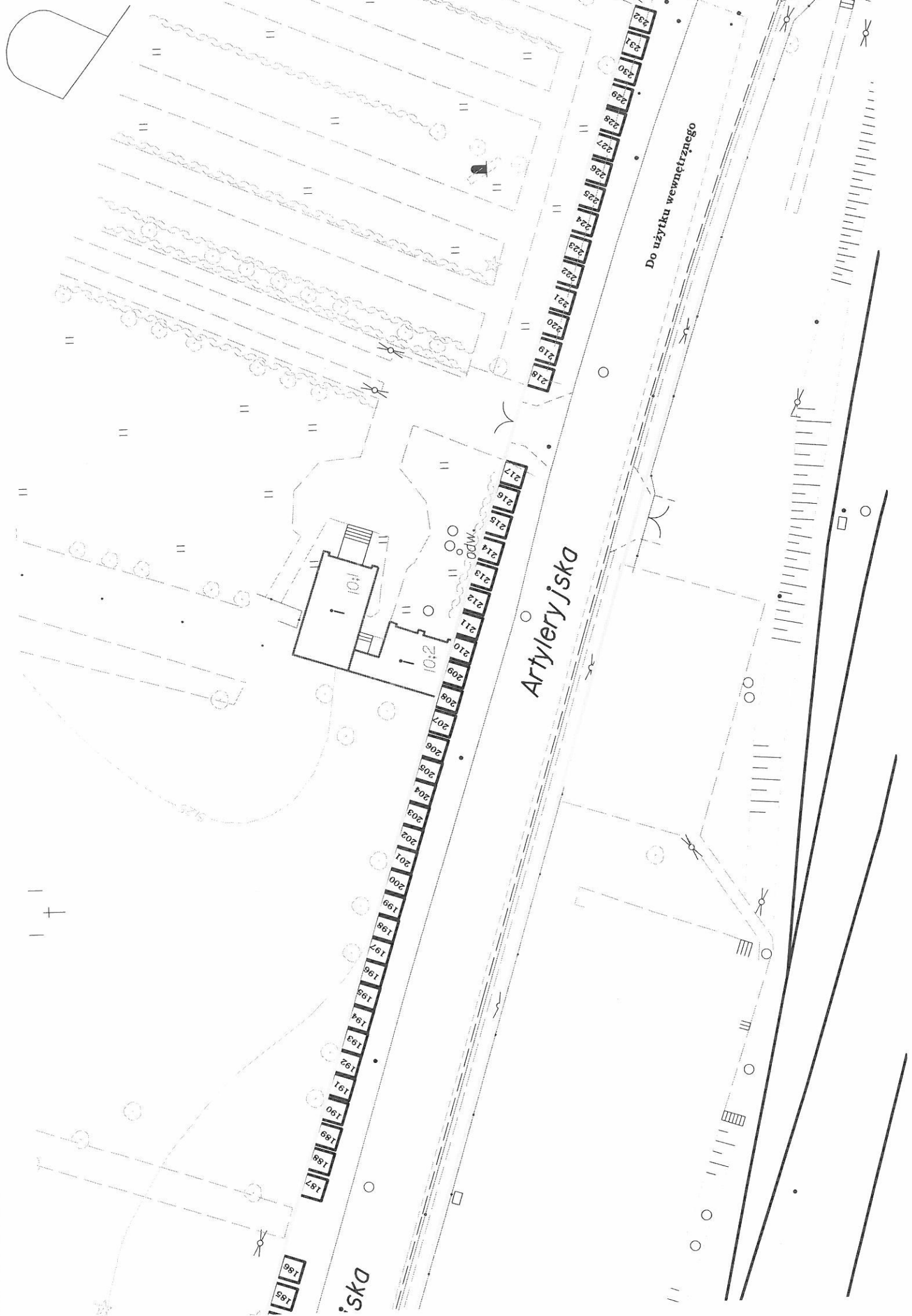

Artylerijska

Do użytku wewnętrznego

iska

+

185
186

187
188
189

190
191
192

193
194
195

196
197
198

199
200
201

202
203
204

205
206
207

208
209
210

211
212
213

214
215
216

217

218
219
220

221
222
223

224
225
226

227
228
229

230
231
232

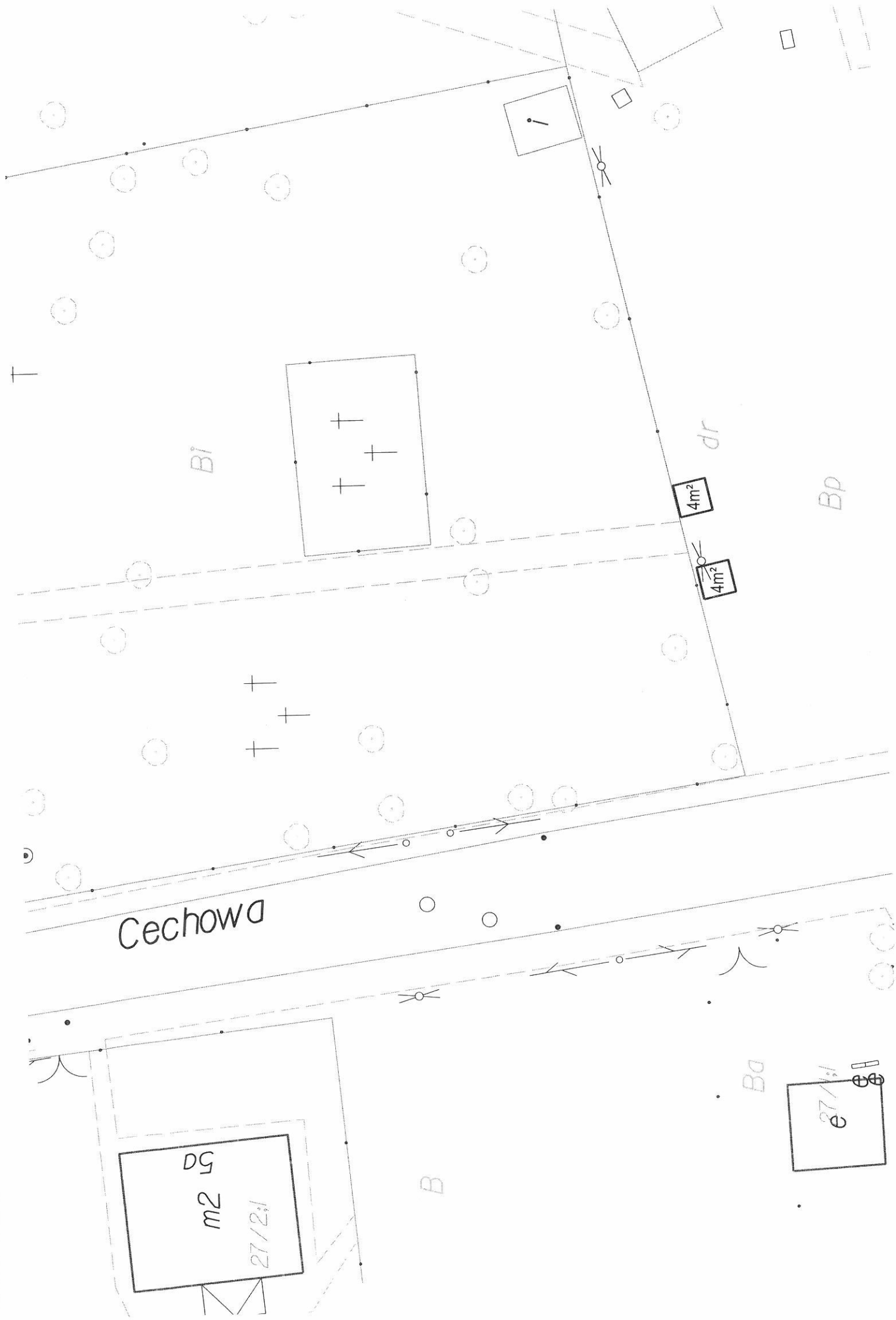

Bi

BP

Cechowa

B

Ba

4m²

4m²

m²
27/21
DG

27/21

dr

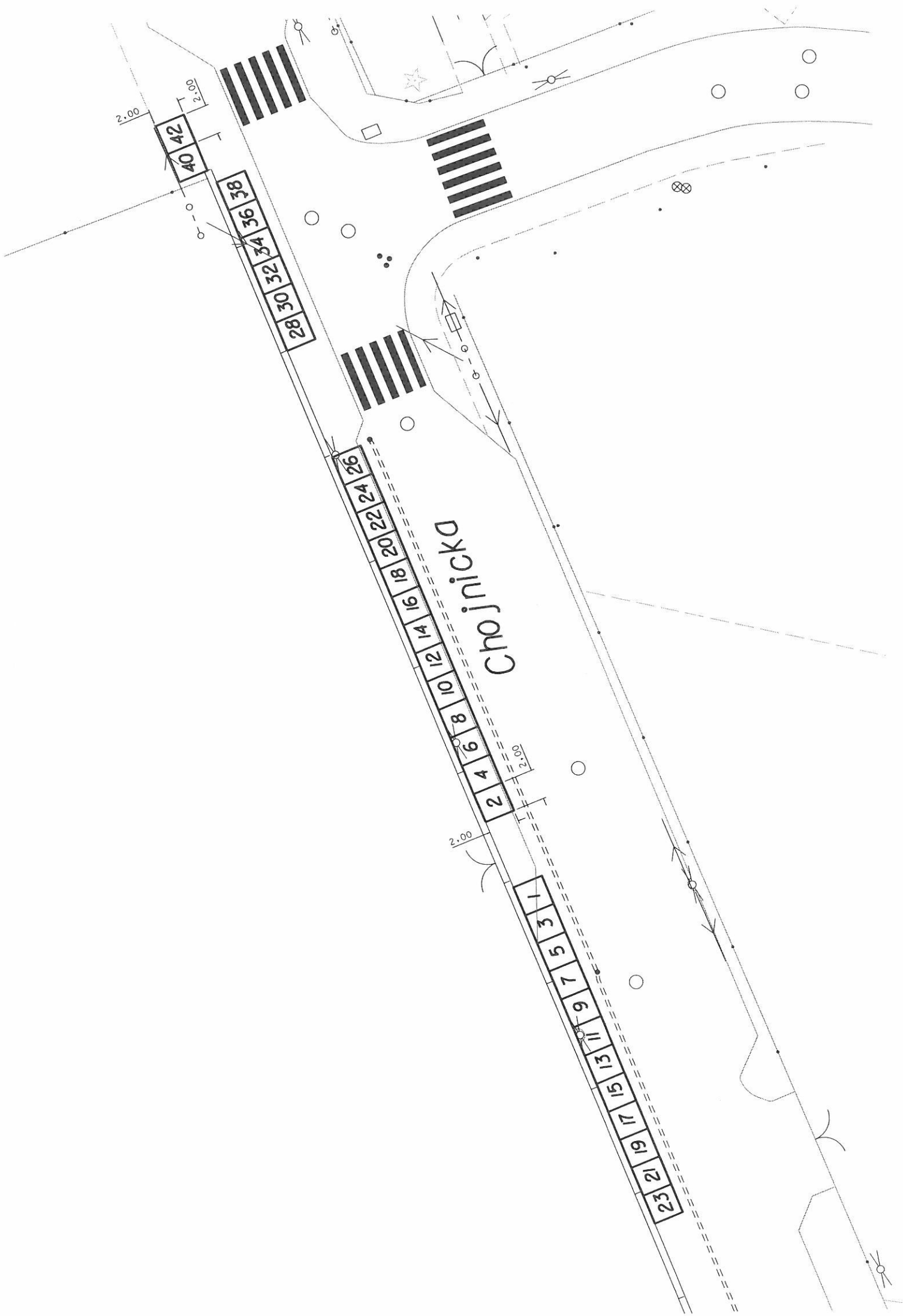

Grunwaldzka

42

4m²

4m²

h

15/2:1

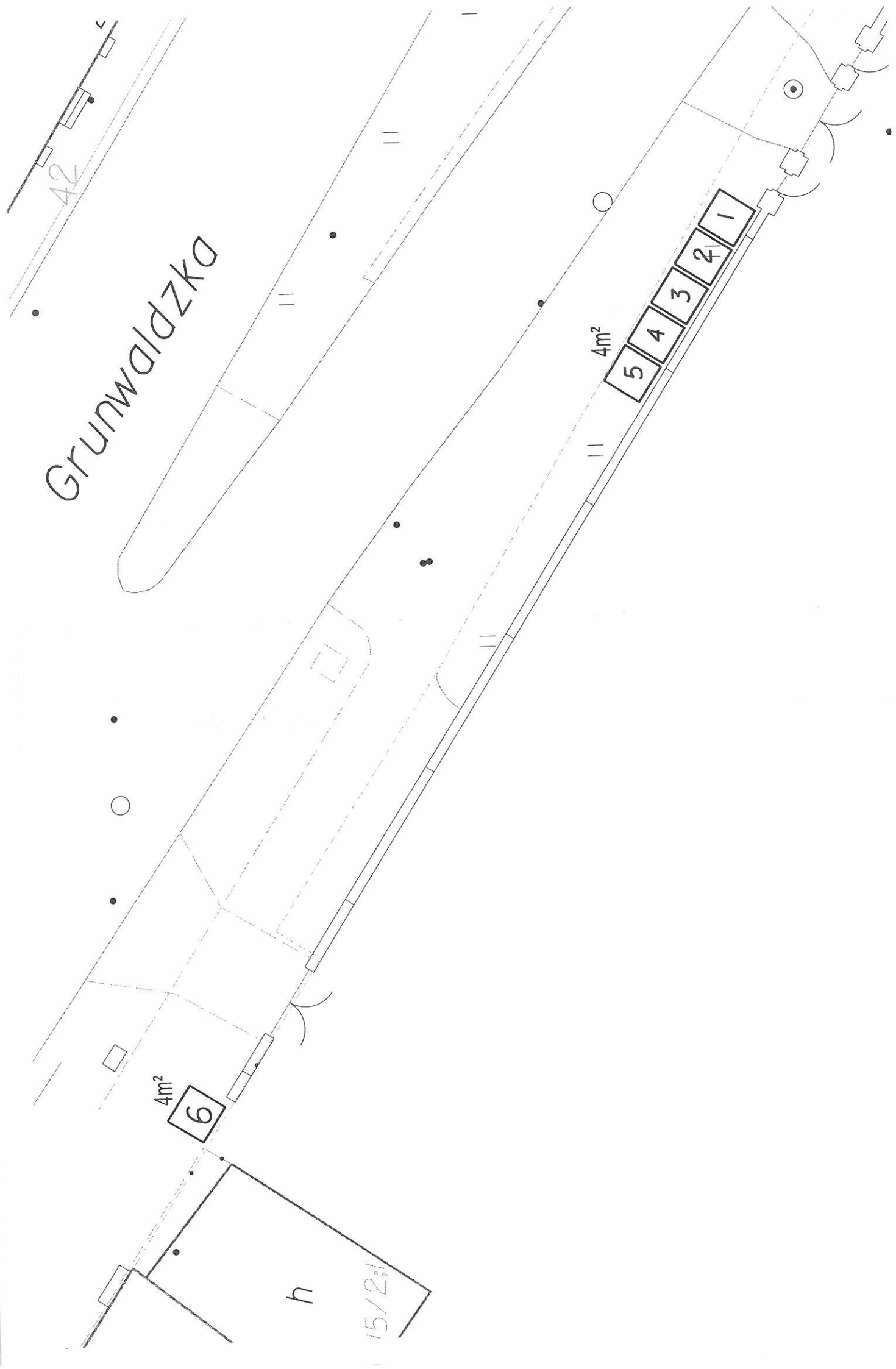
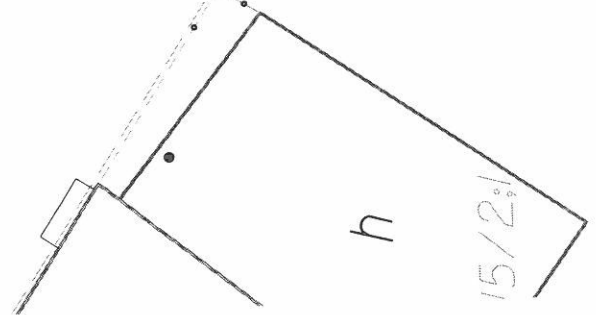
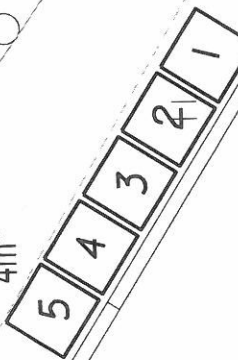

ch.kostka

Parking

Parking

Jaskółcza

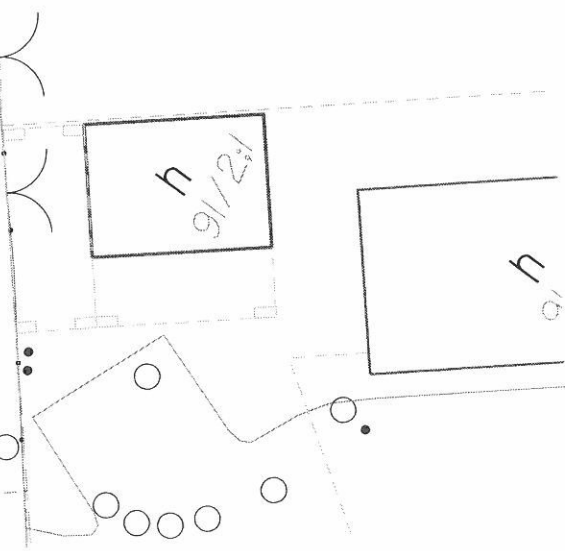
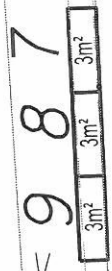

42/3:19
42/3:21
42/3:22
42/3:24

kostka bet.

śm.

ch.kostka

parking

parking

Jaskółcza

dr

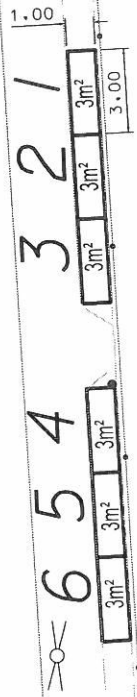

Kapliczna-Płońska

9 rekl.

Forpokońsko

10
5m² 5m²
9
4m²



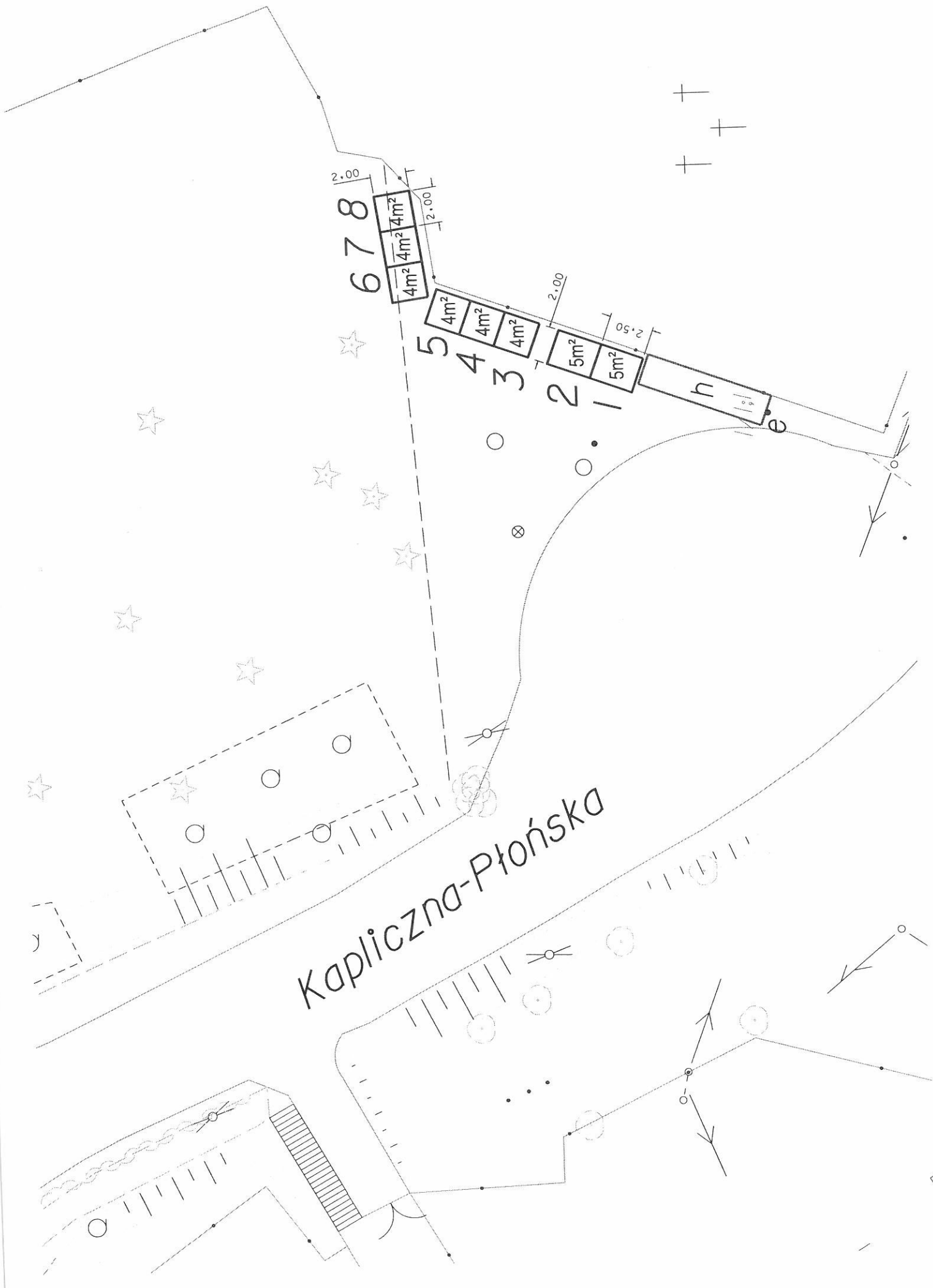

+

+

+

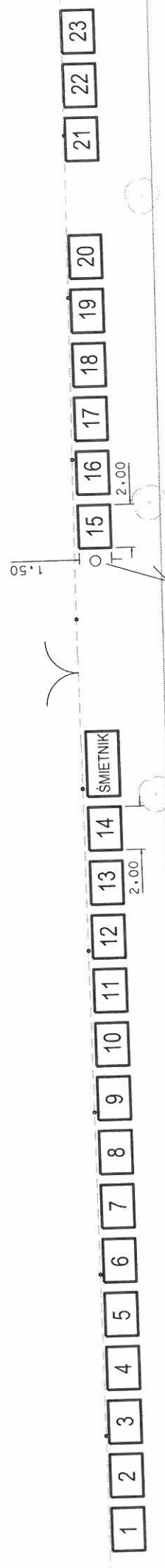

KOSSAKA

A B

e

Polbr.

Pol

//

.

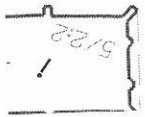
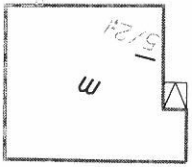
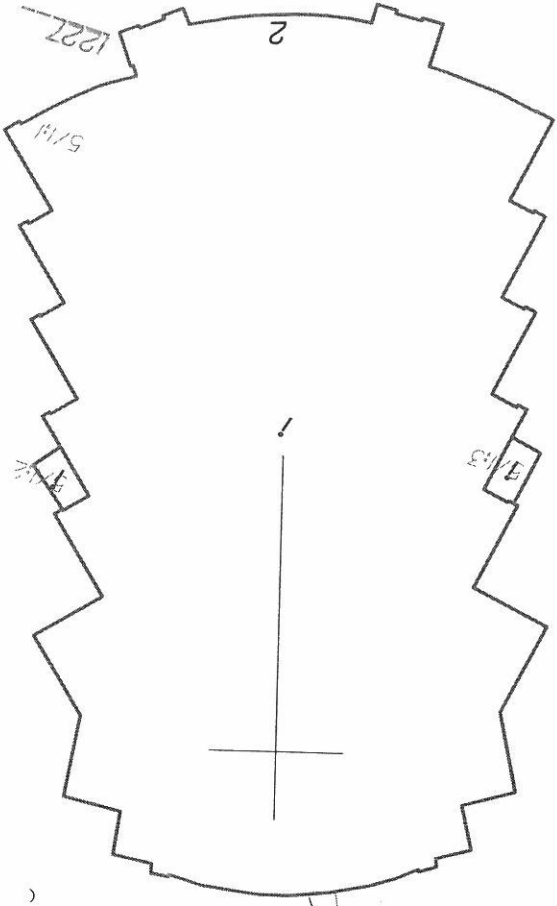

Lotników

Lotników

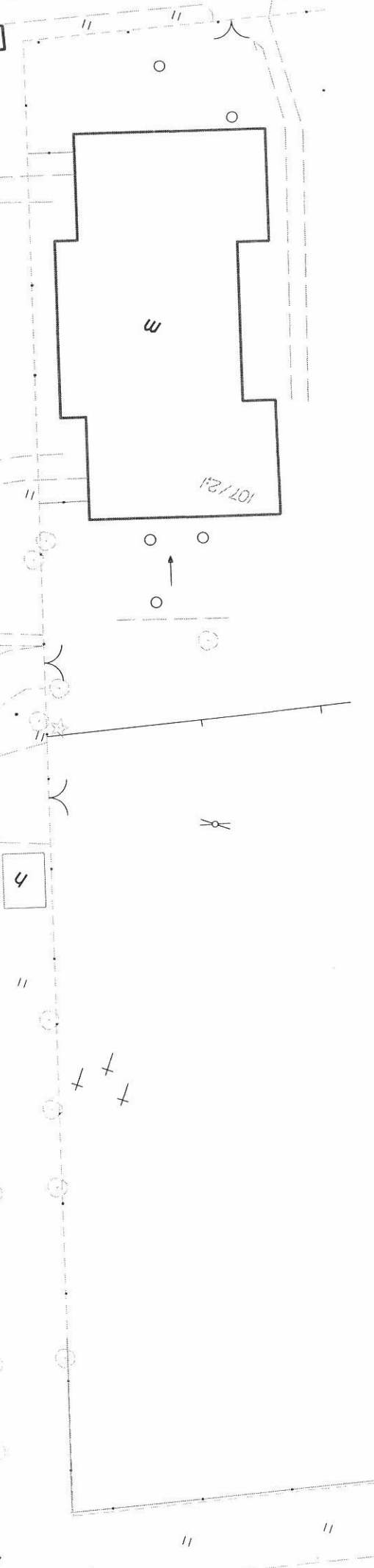
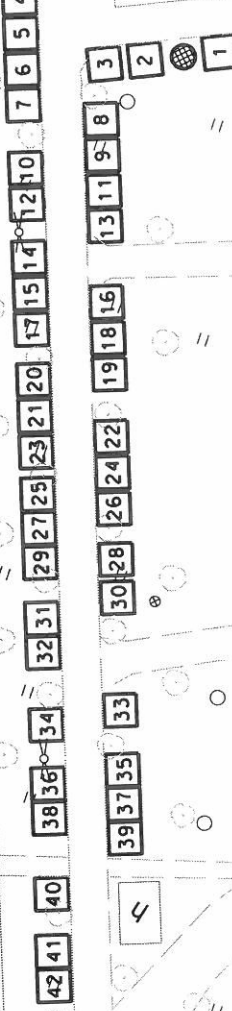
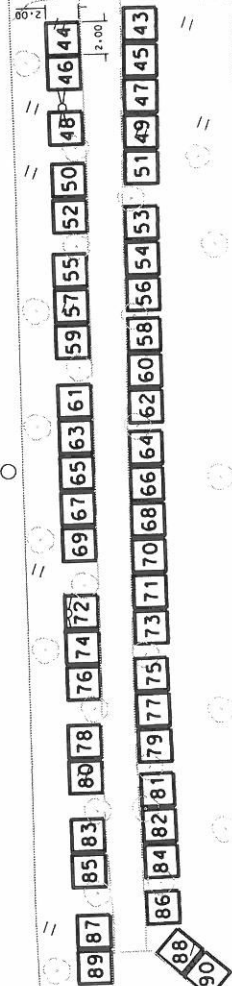

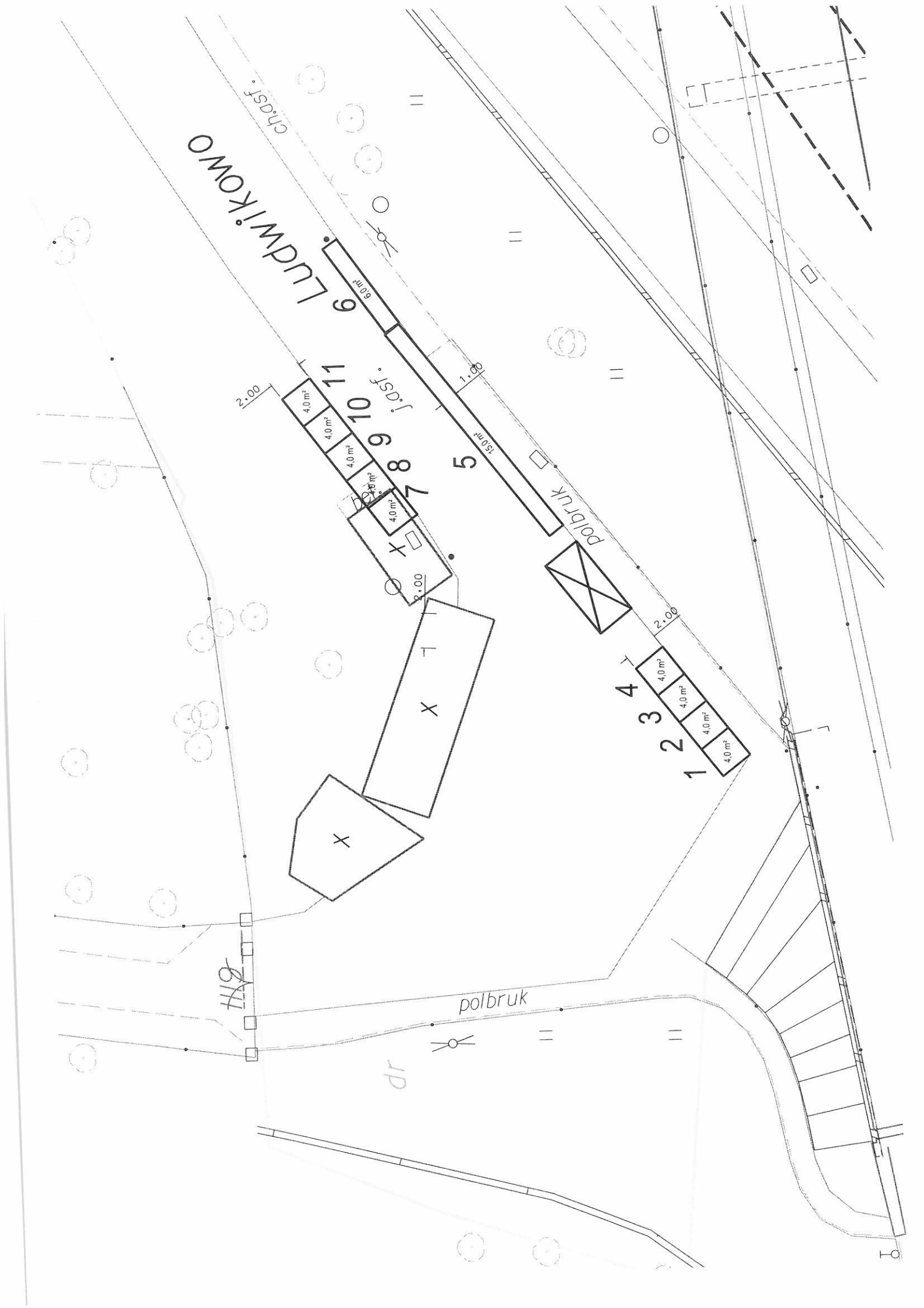

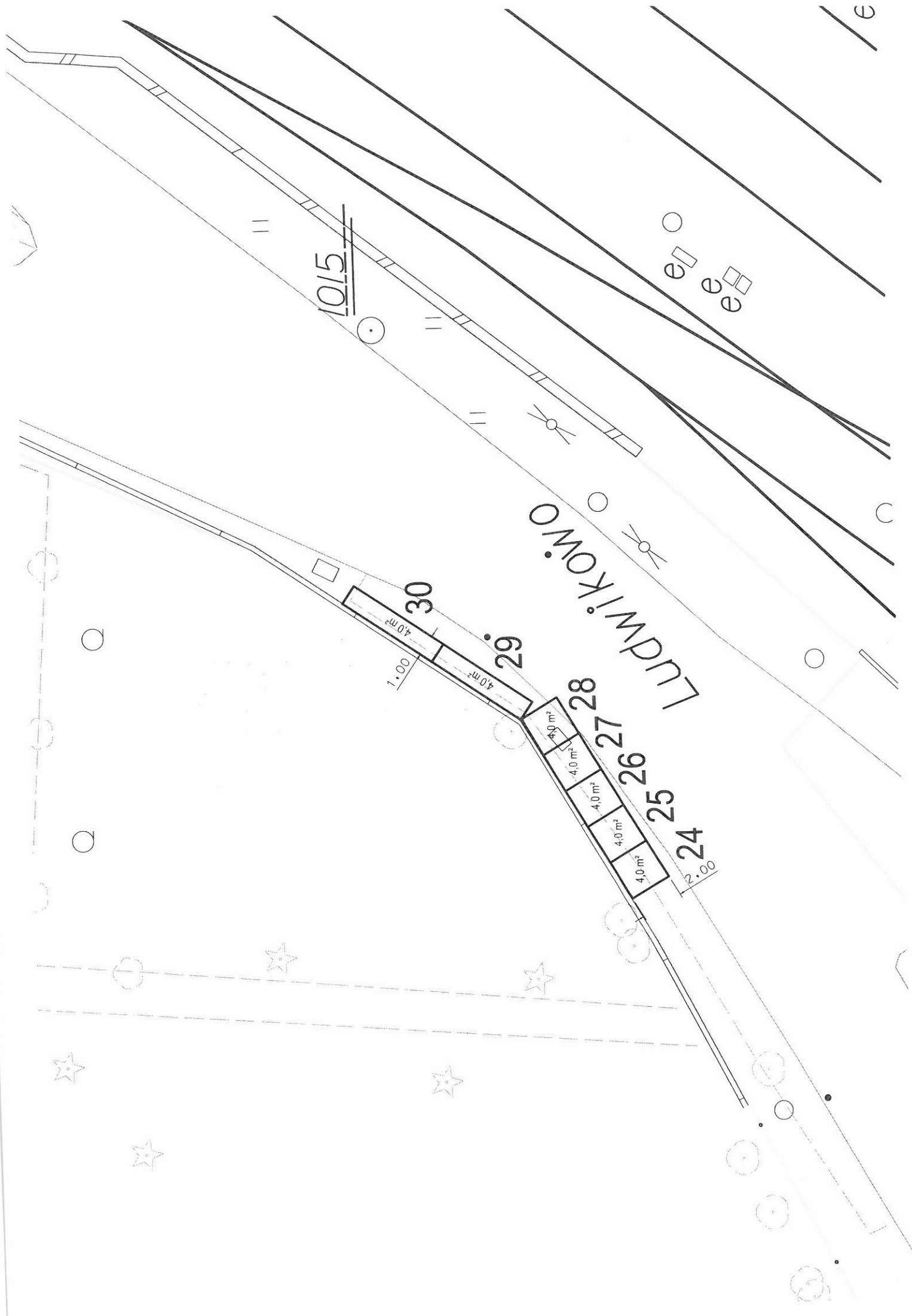

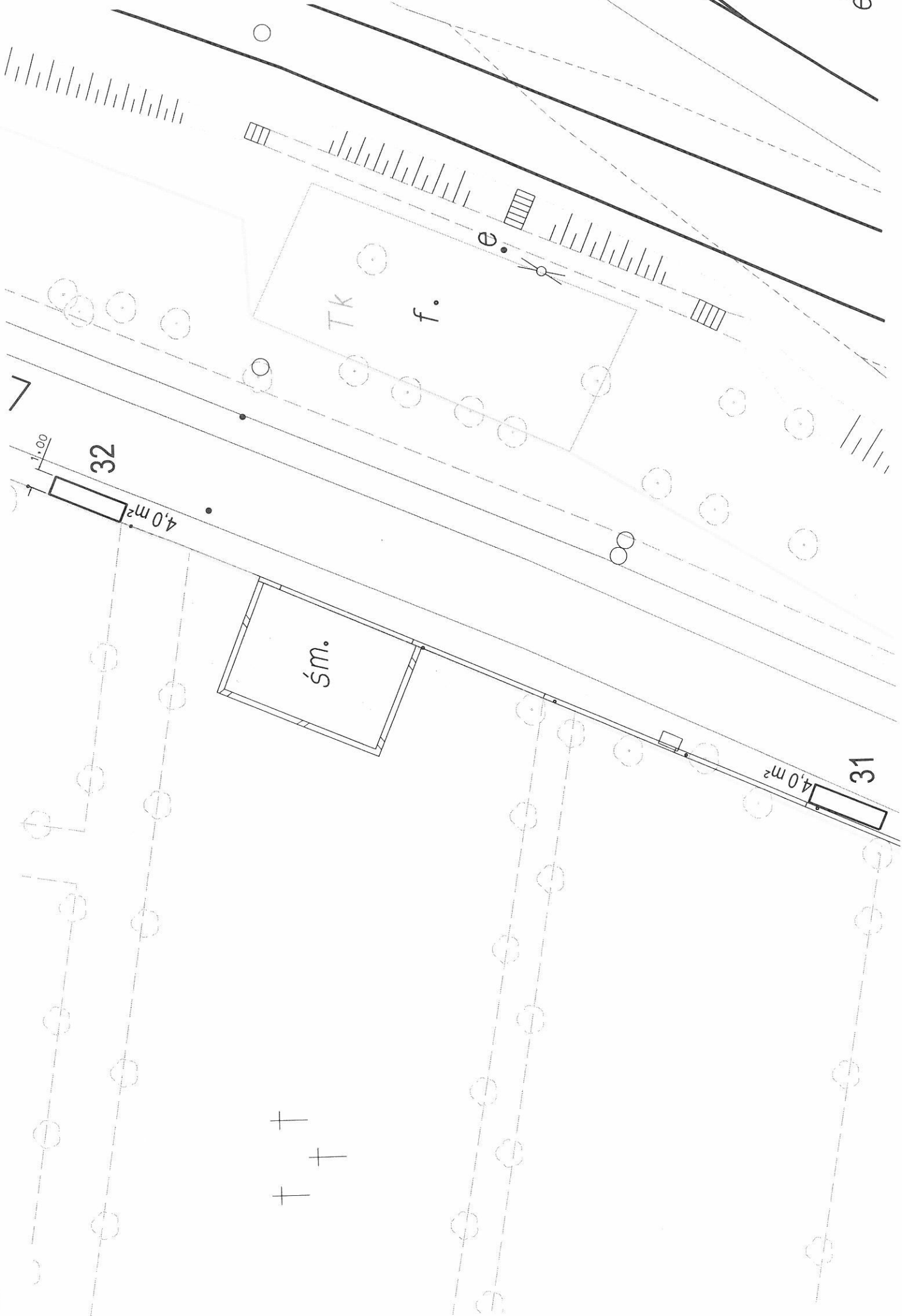

40

70.43

16,0 m²

Łabiszyńska

12,0 m²

10

12

m²



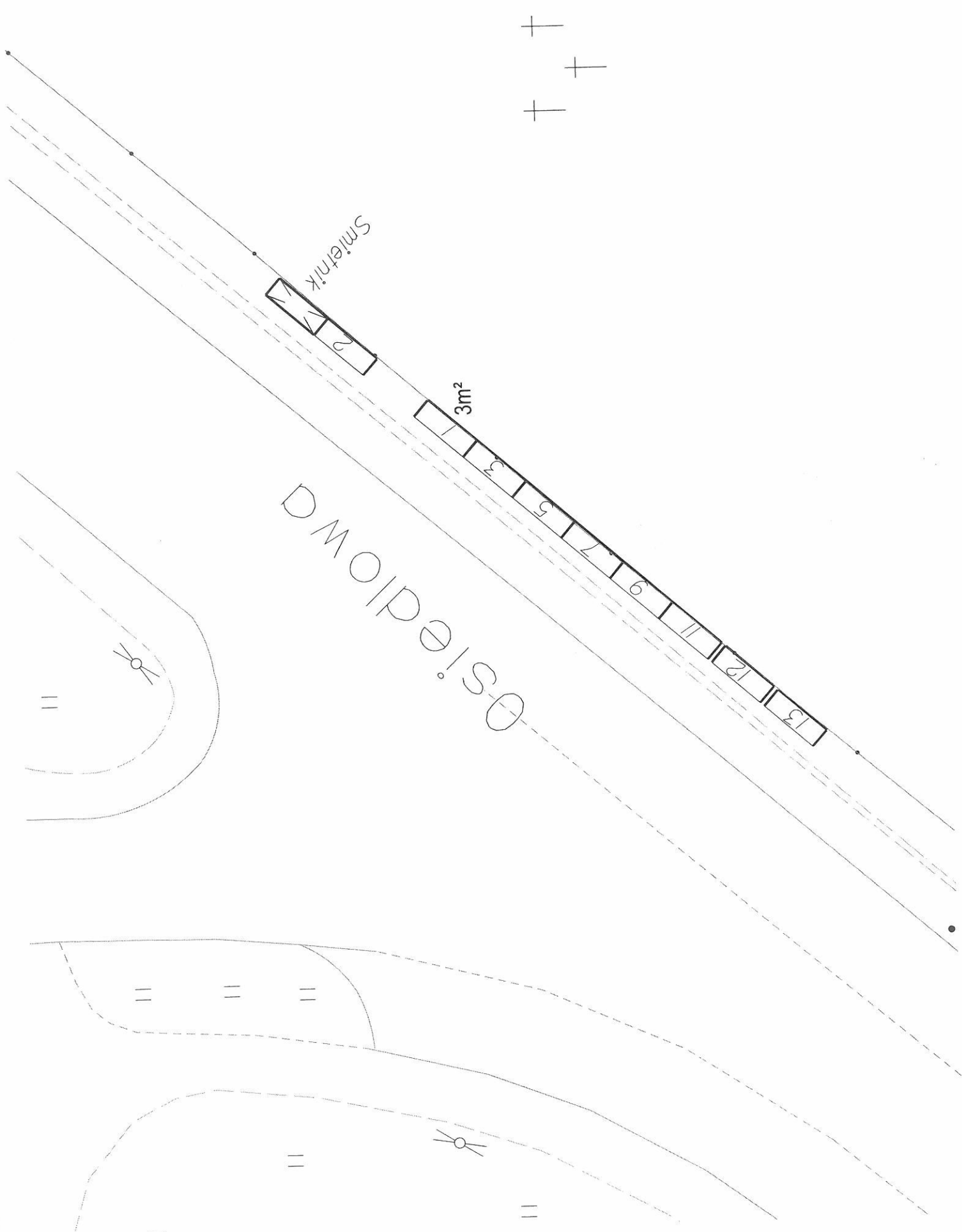

C O 4102

Bp

W

ch. polbruk

polbruk

299,4

W.

e

P!ASTOWD

Bp

4m²

4m²

2

1

+ +

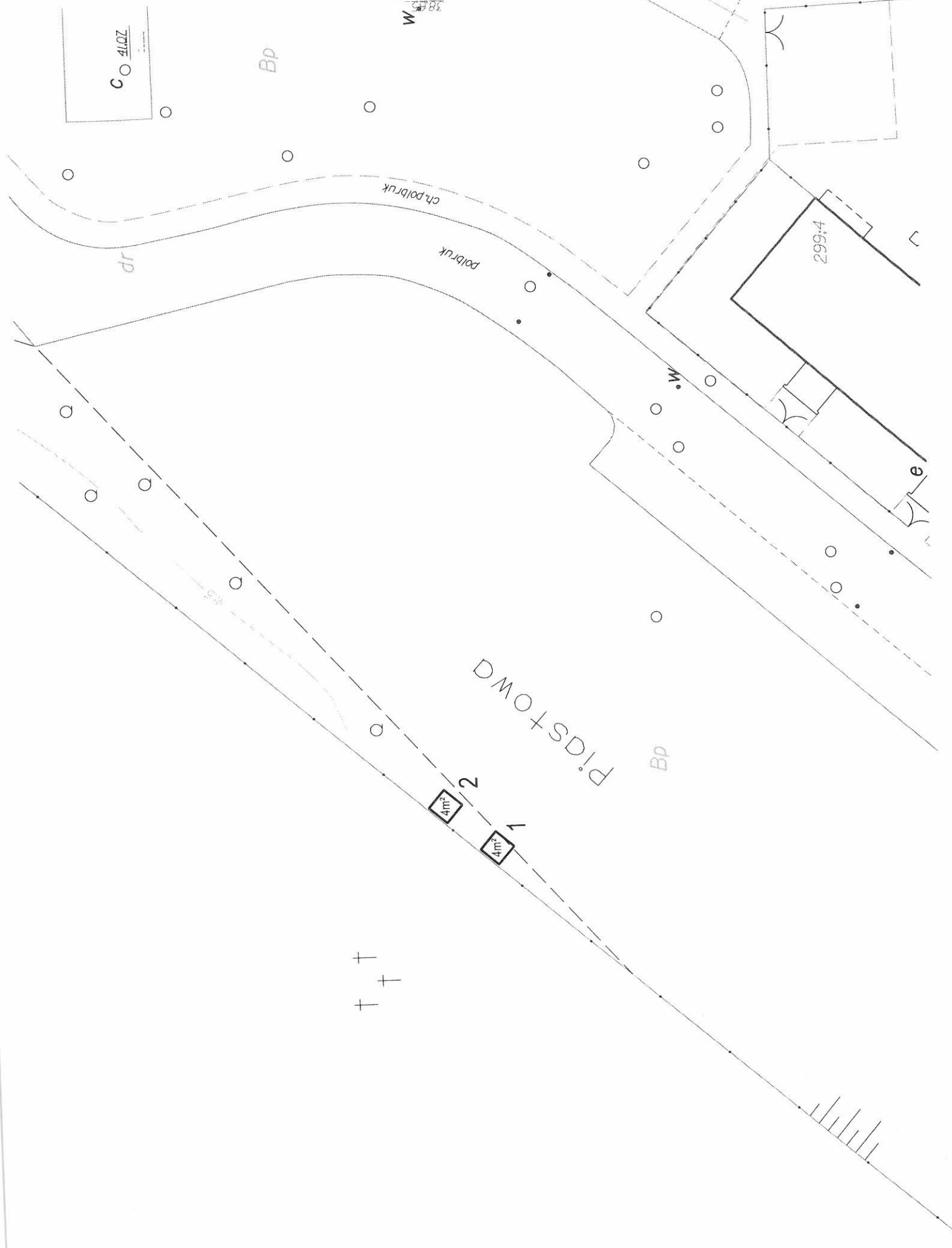

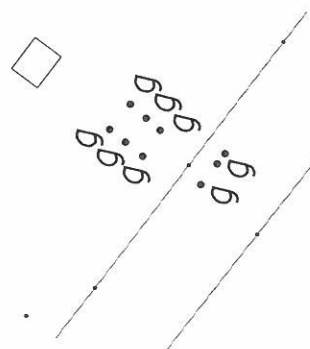
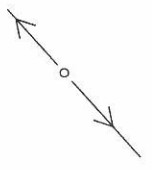
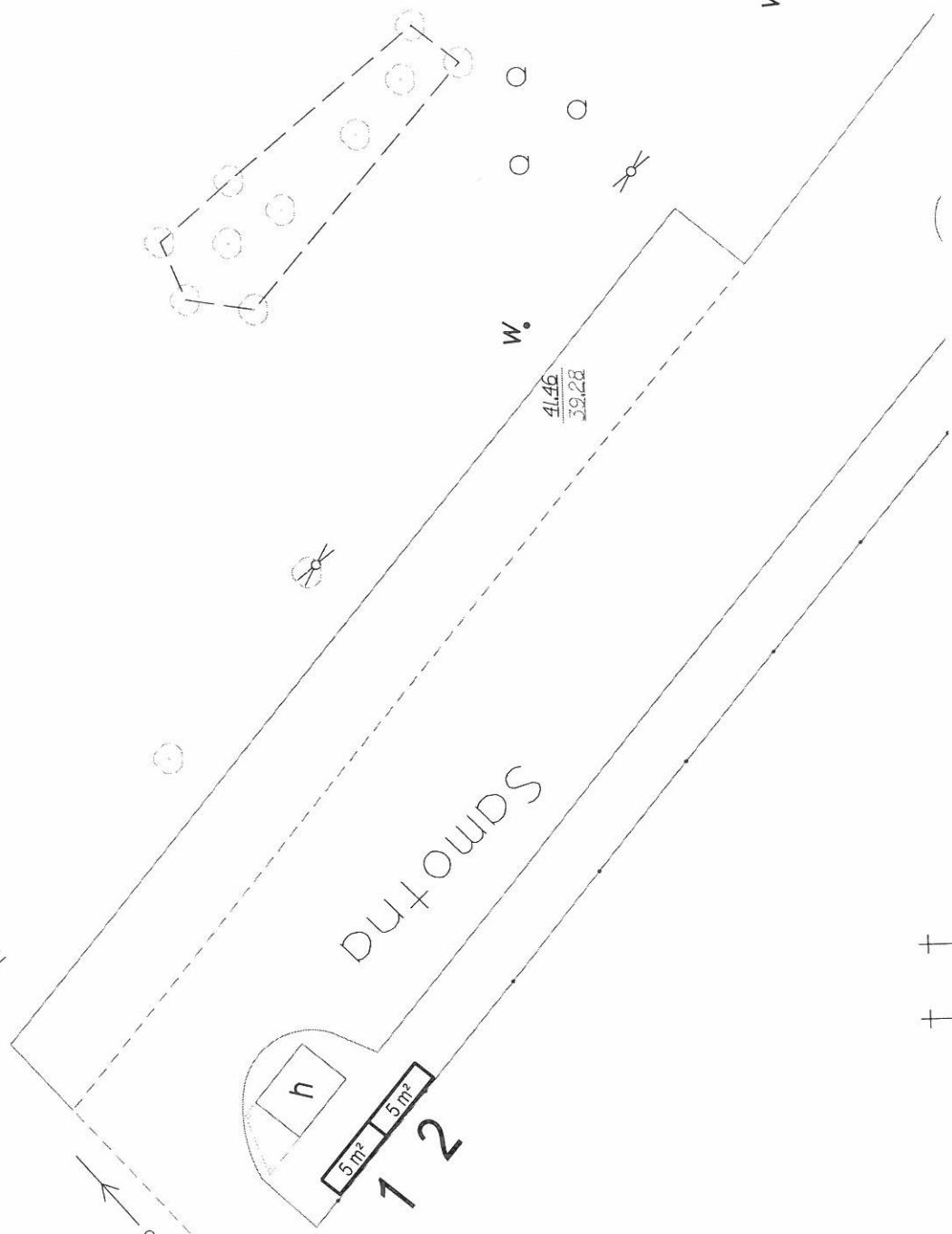
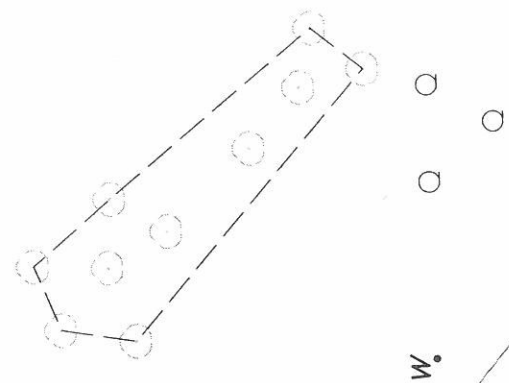
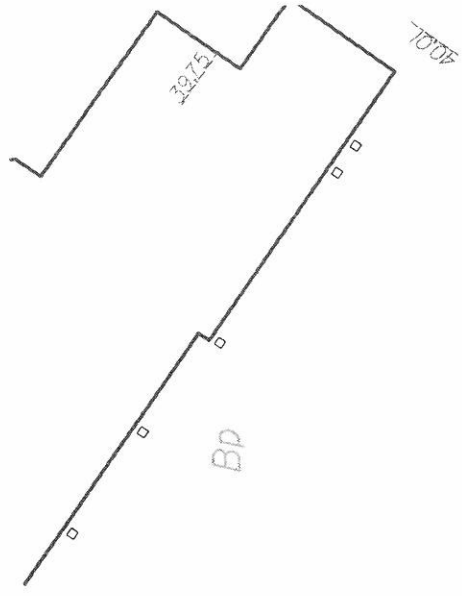

+ +
+ +

+ , +

W. ⊗

W.

41.46
32.28

DUTOWDS

1 2

5 m² 5 m²

BD

3275

3276

Bo

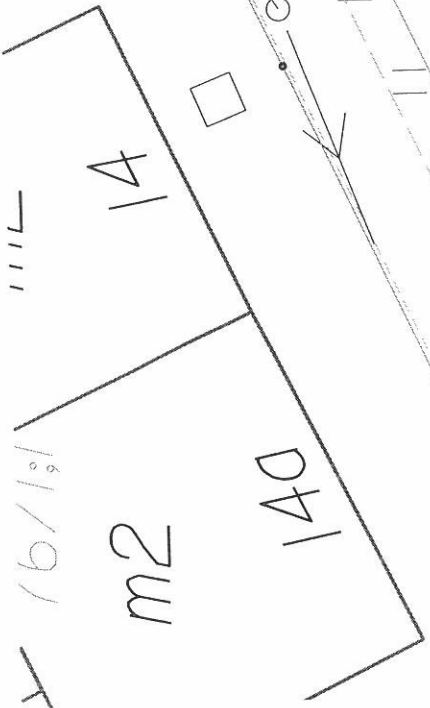

Остроград

Читунз

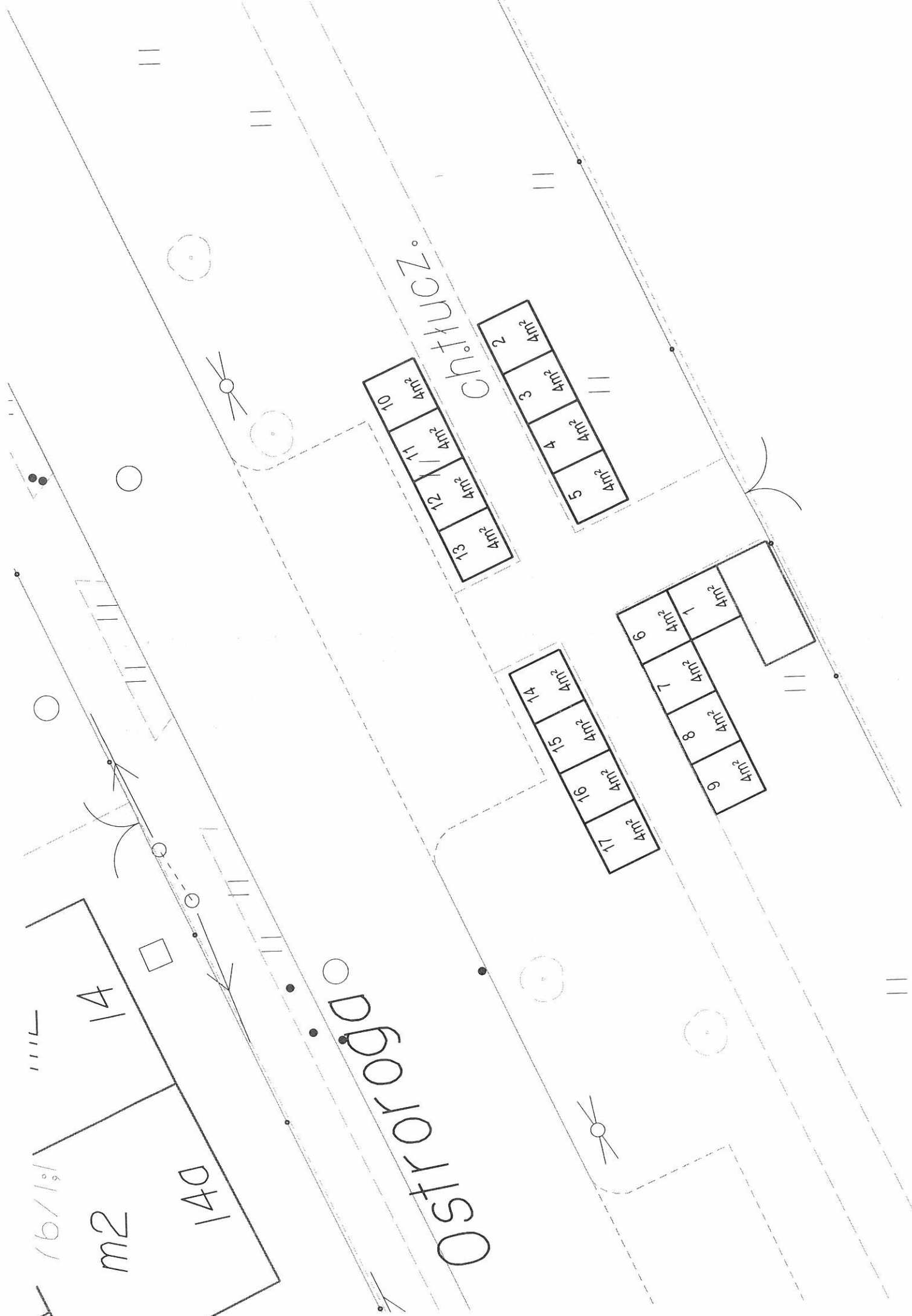
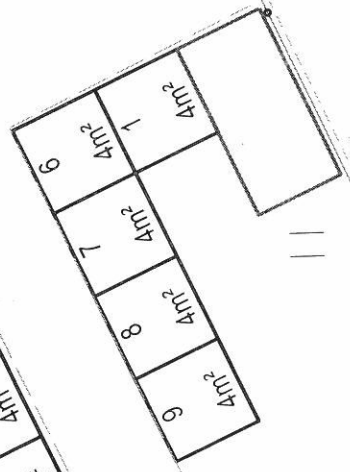
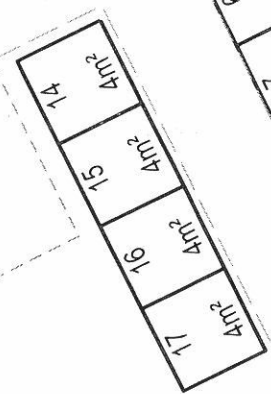
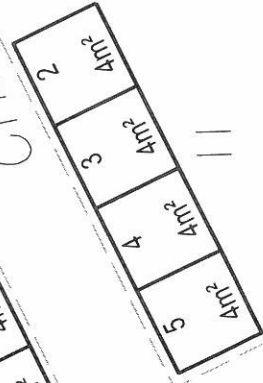
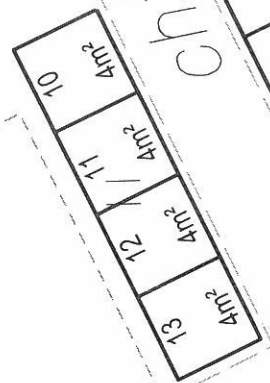

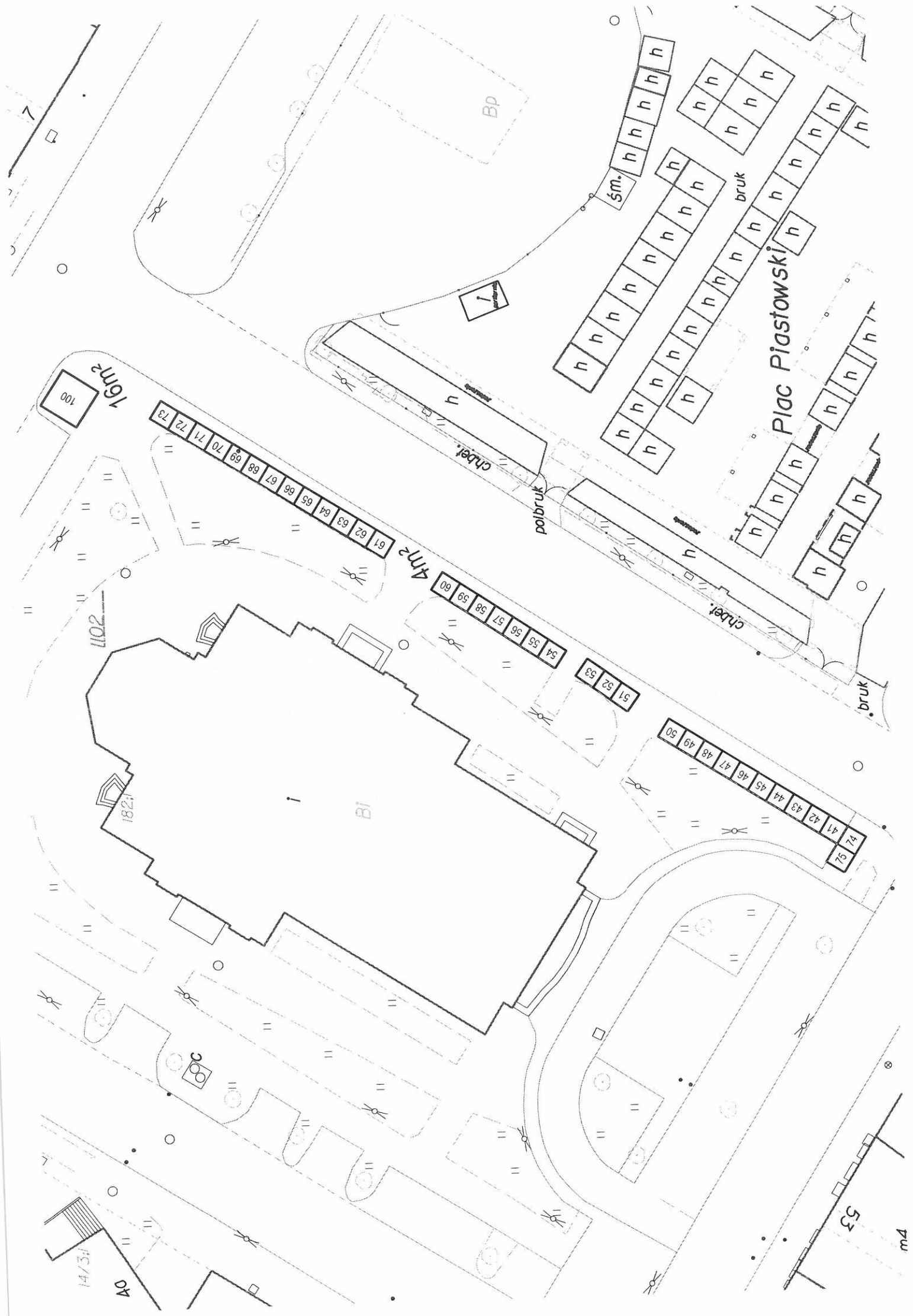

Bp

sm.

bruk

Piłsudski

chbet.

polbruk

chbet.

bruk

16m²
100

61 62 63 64 65 66 67 68 69 70 71 72 73

4m²

54 55 56 57 58 59 60

51 52 53

41 42 43 44 45 46 47 48 49 50

1102

1821

BI

14/34

40

53

m4

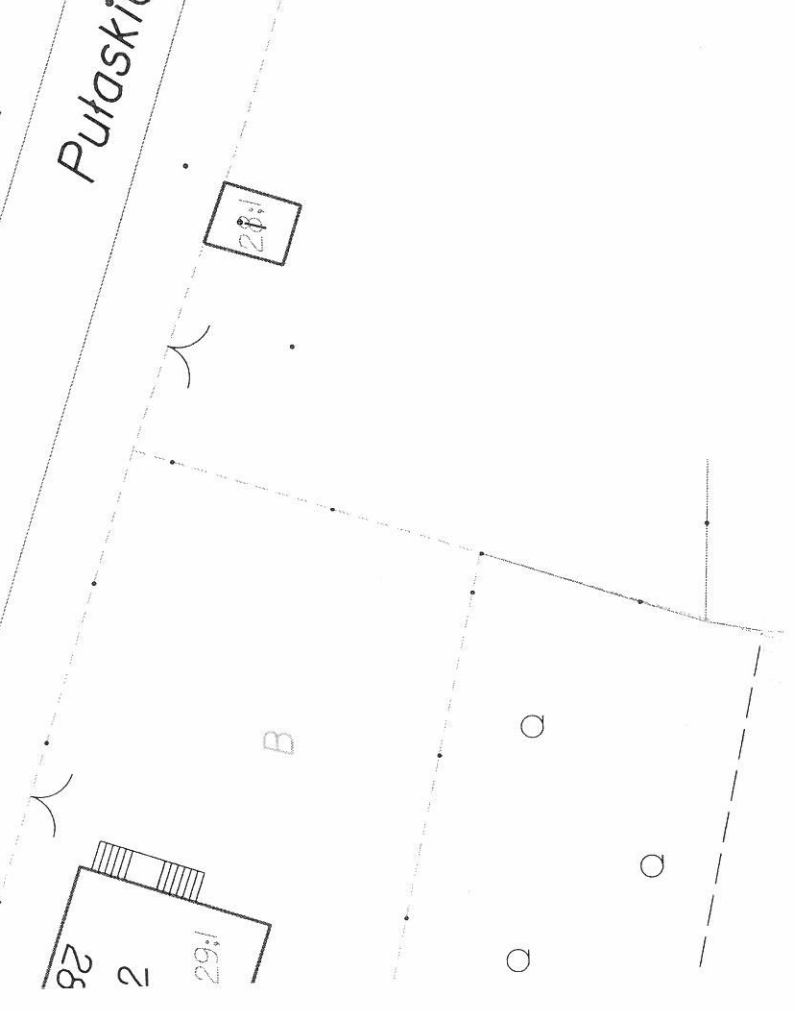
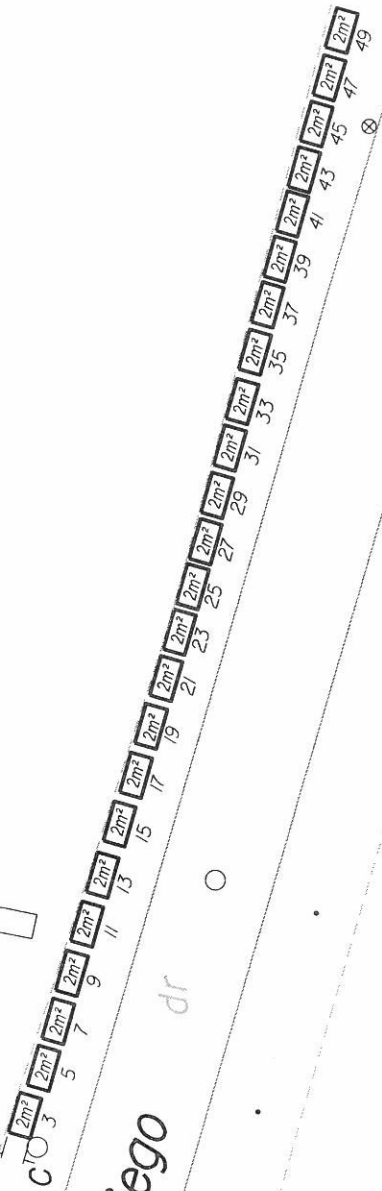
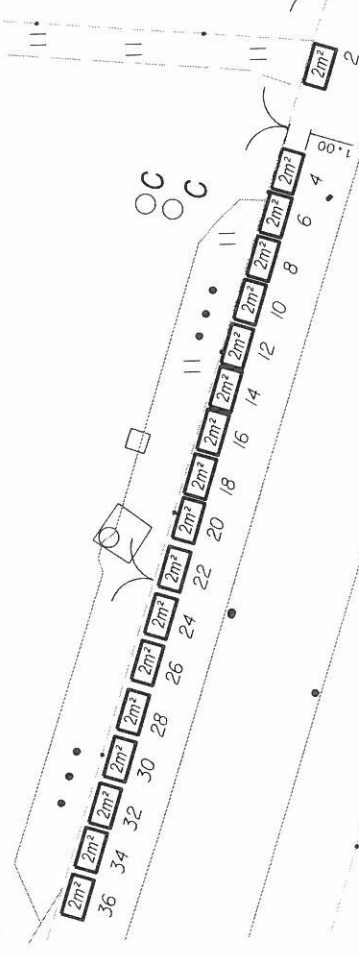

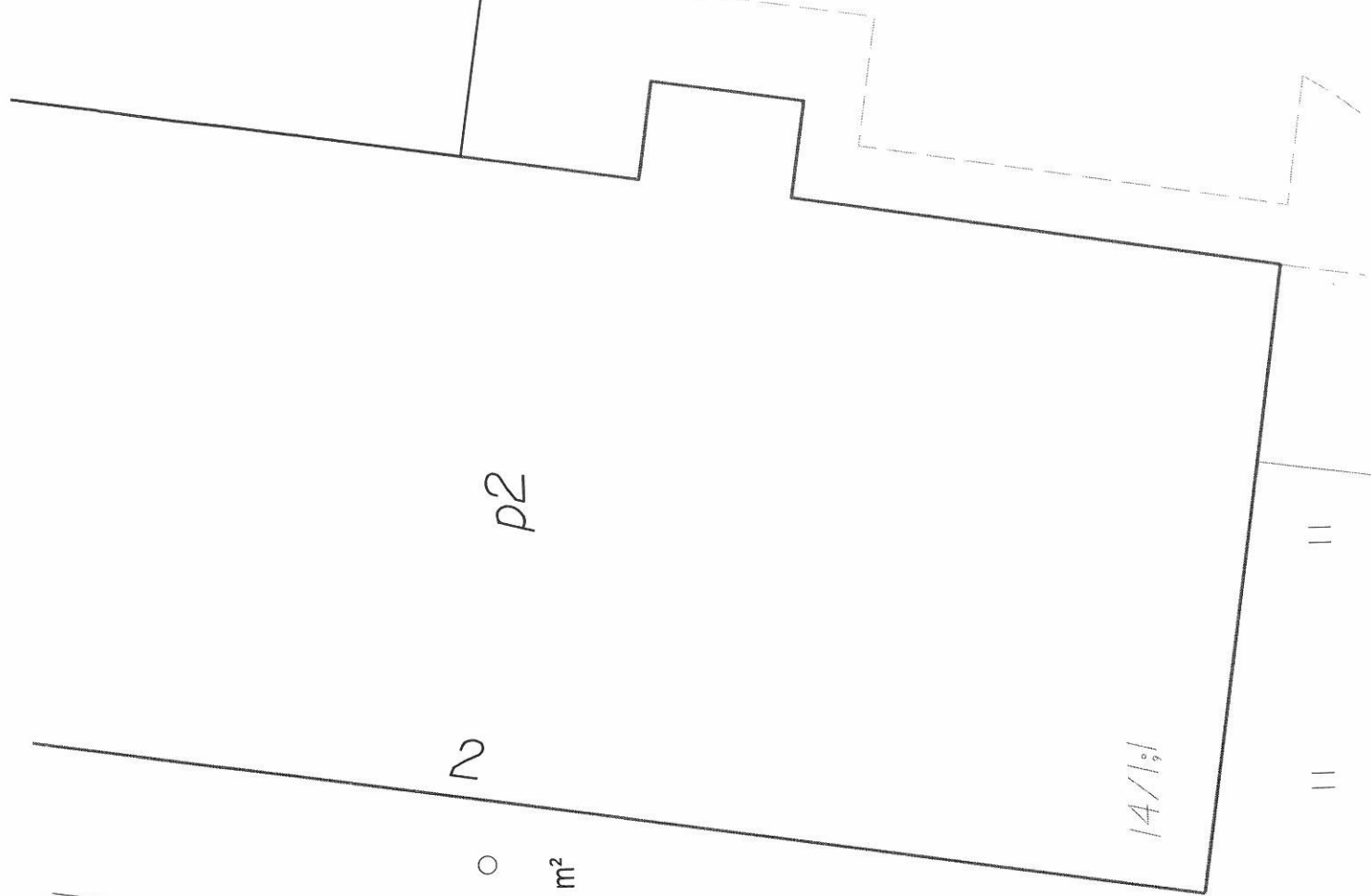

p2

2

14/19/1

12,0 m²

9,0 m²

RYNKOWSKA

12/27



SKROMND

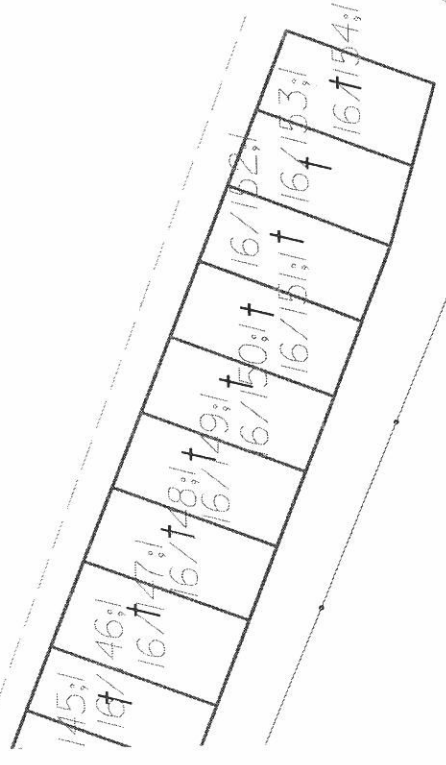
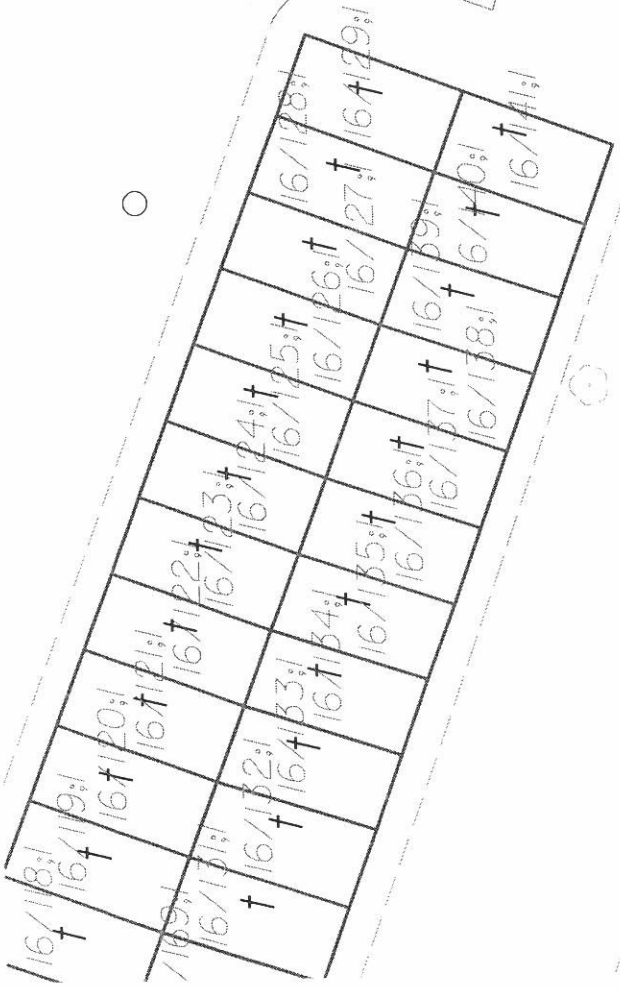
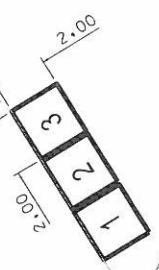
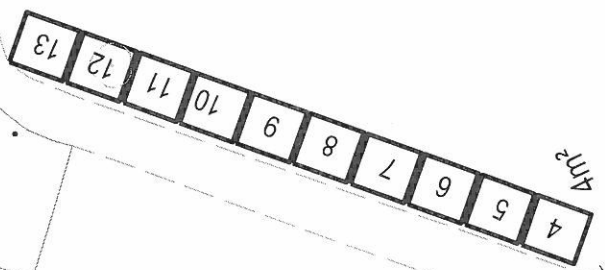

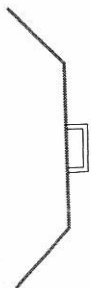

do użytku wewnętrzznego ZDMiKP

do użytku wewnętrzznego ZDMiKP

do użytku wewnętrzznego ZDMiKP

do użytku w

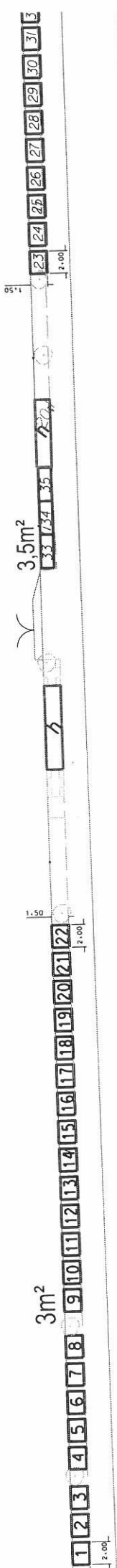

Stawowa

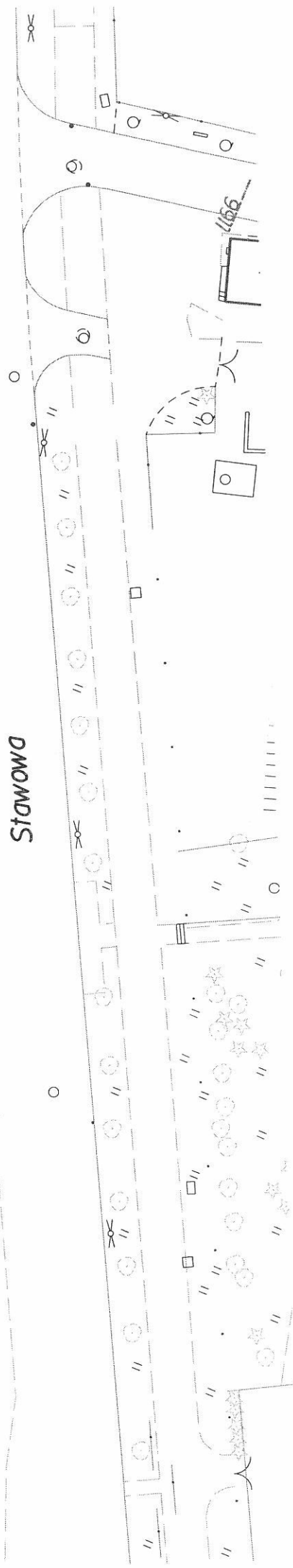

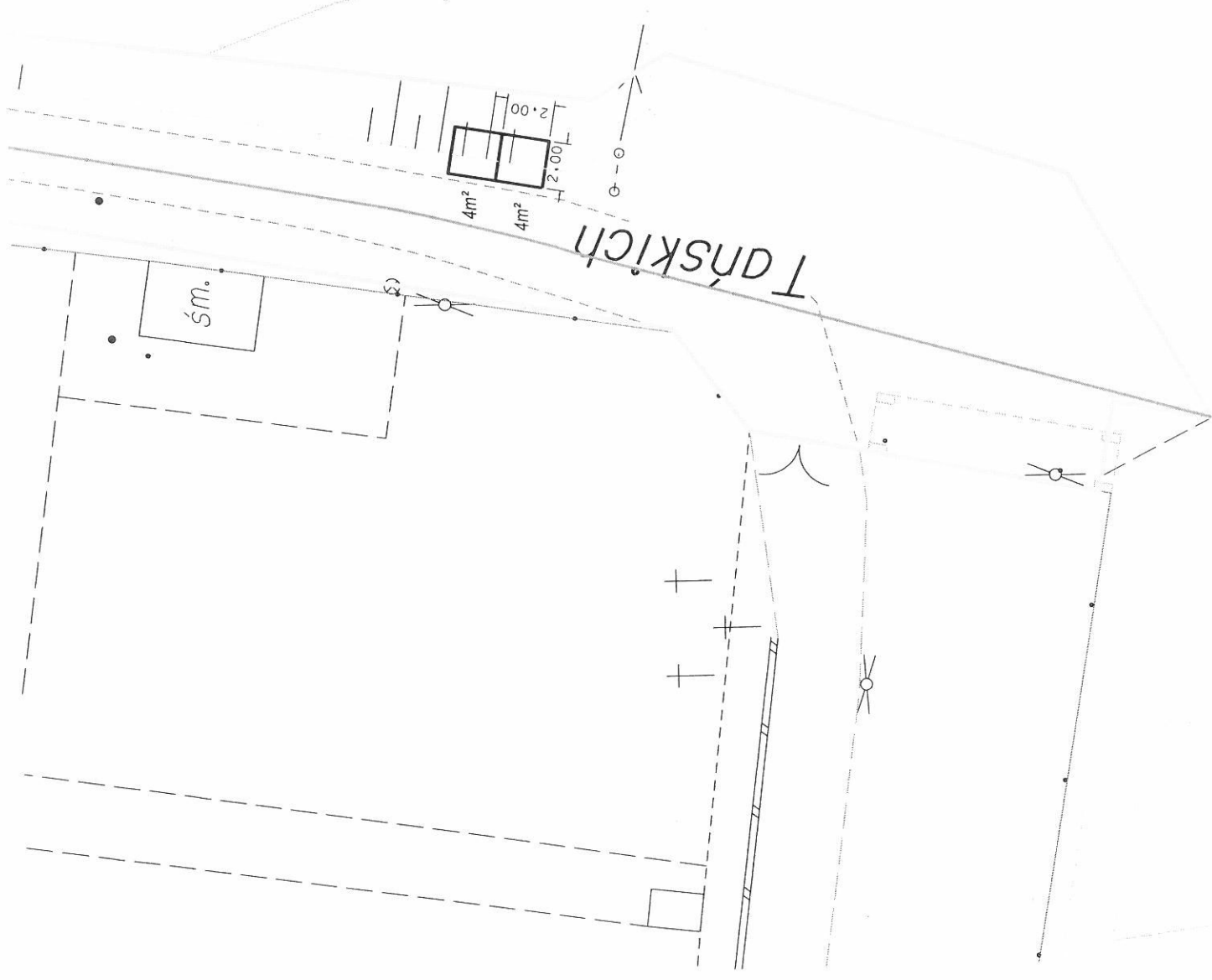
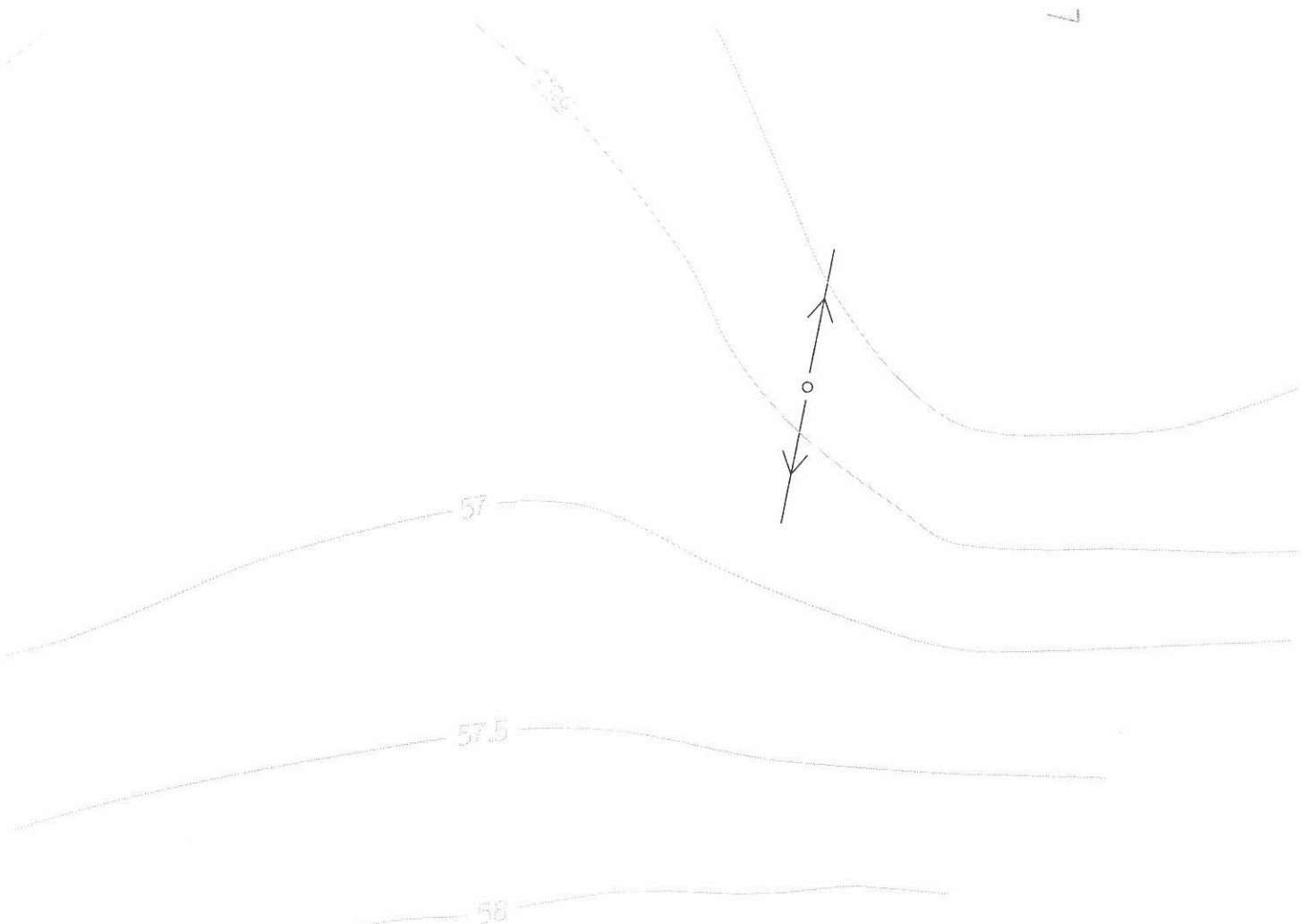

Toruńska

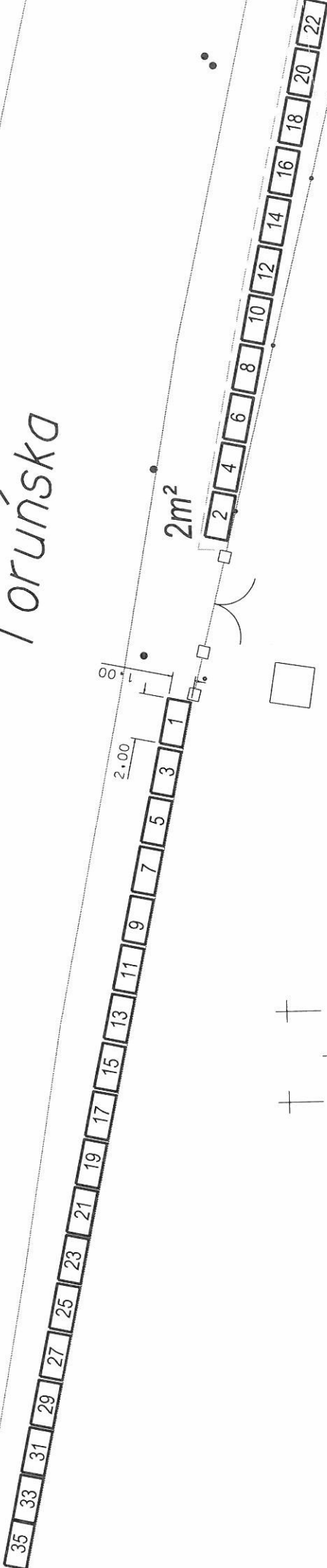

+ +
+ +

+ +
+ +

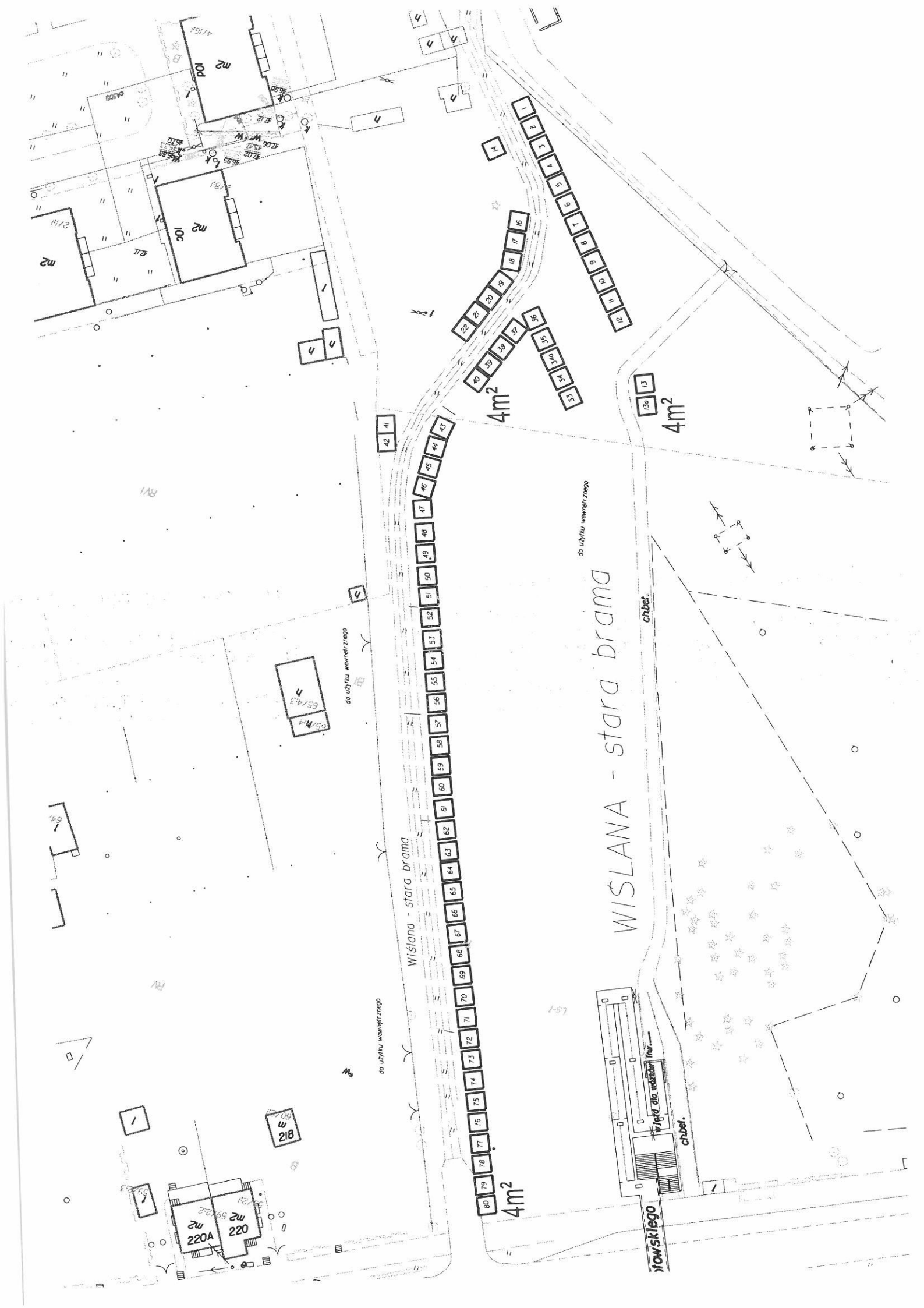

Wisłana

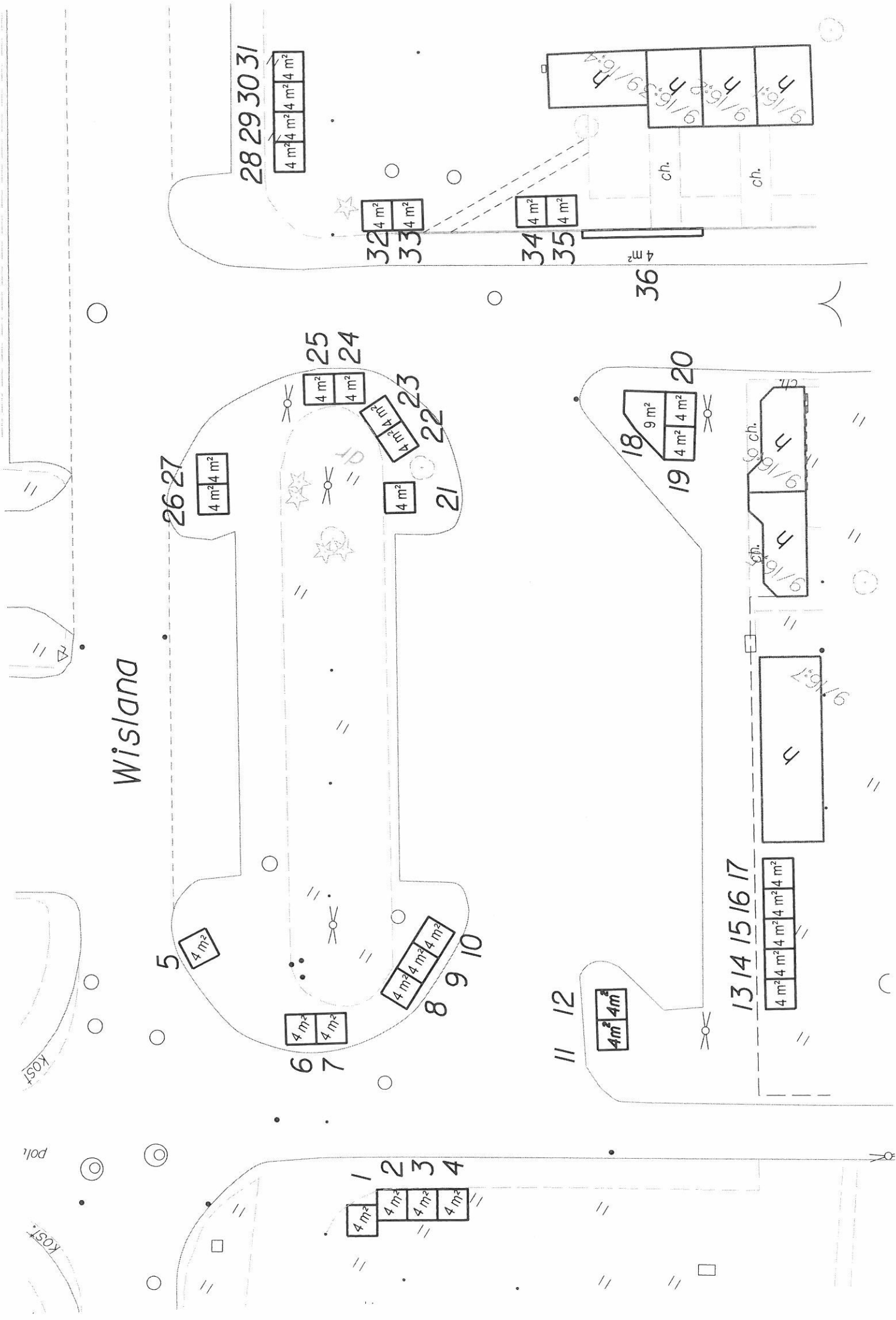

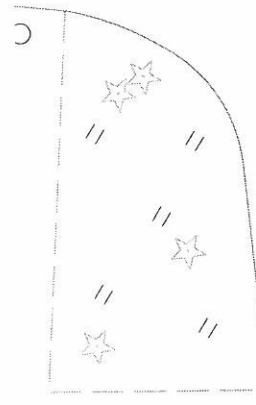
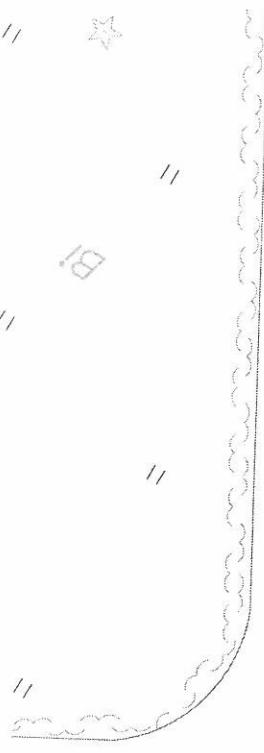

47.8

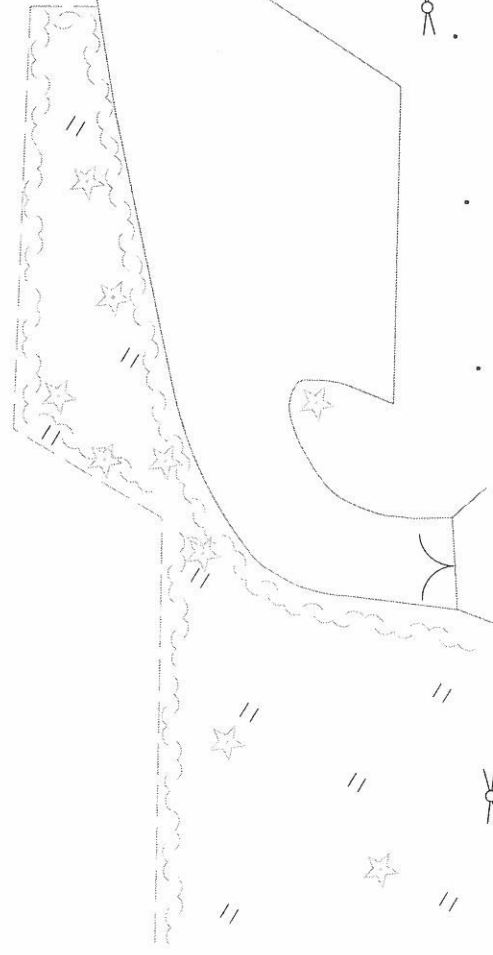

Wiślanã

Wiślanã

1	18,0 m ²	2	21,0 m ²	3	18,0 m ²	4	10,0 m ²
5	9,0 m ²	6	9,0 m ²	7	9,0 m ²	8	12,0 m ²

Wyszyńskiego

|| piezomet

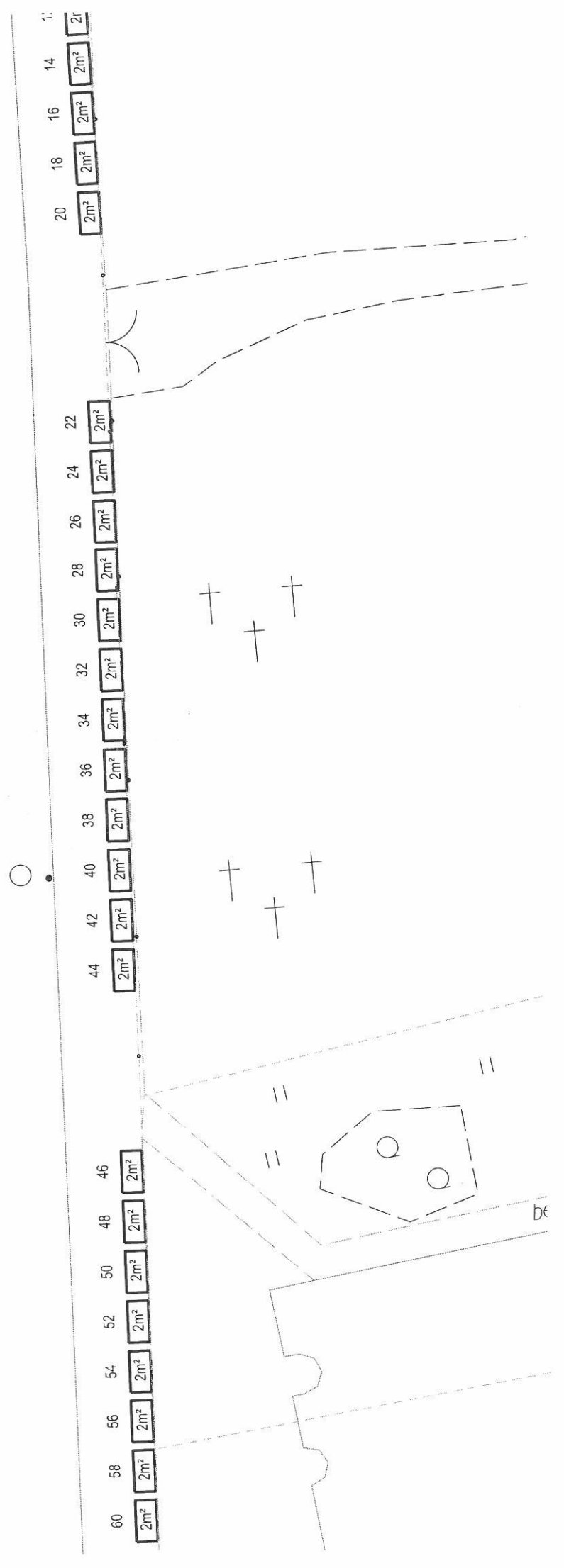
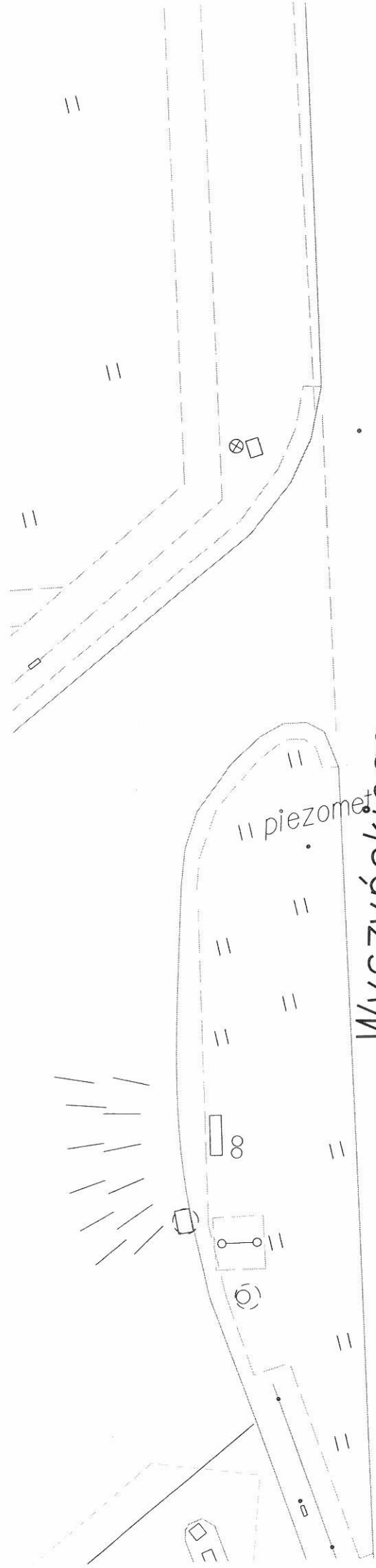

Wyszyńskiego

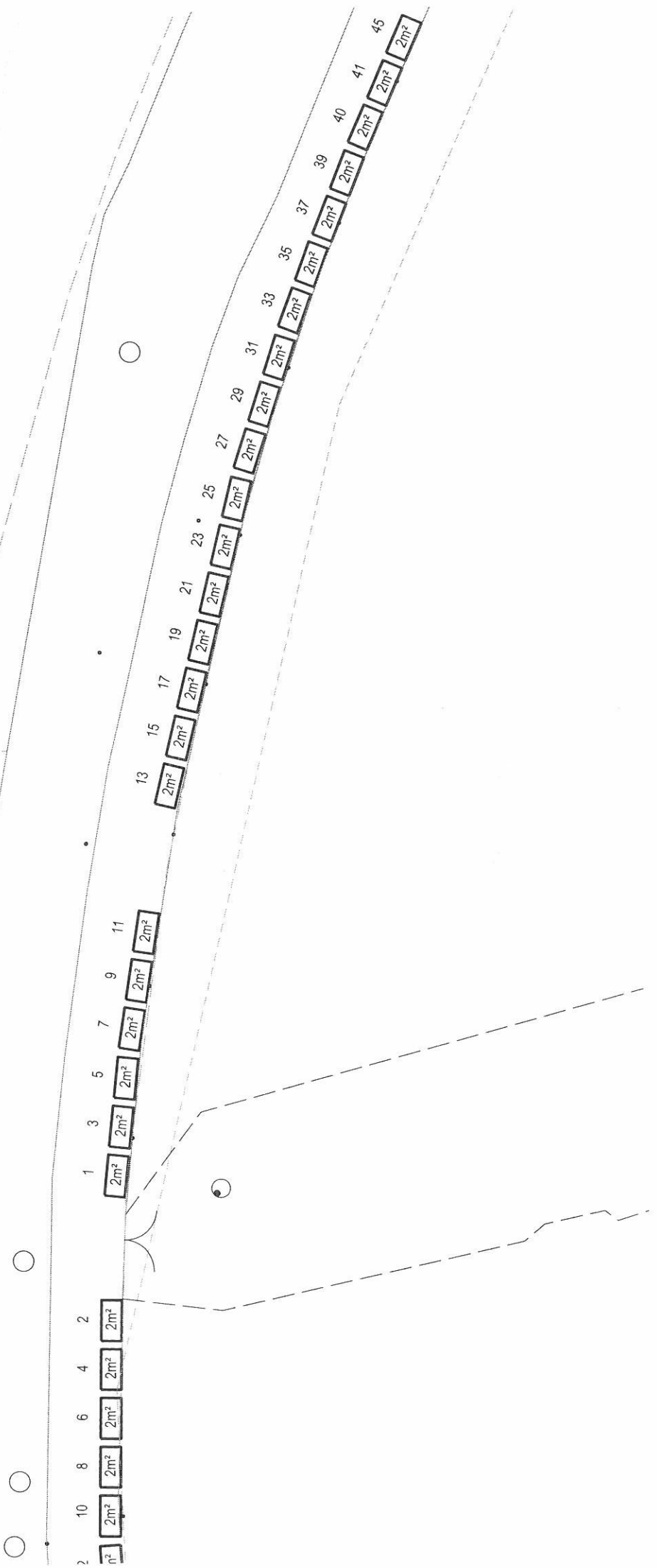

Zaświat

